

ENGINE	STD	OPT
Hyundai HM5.9 engine	●	
HYDRAULIC SYSTEM	STD	OPT
Intelligent Power Control (IPC)		
3-power mode, 2-work mode, user mode	●	
Variable power control	●	
Pump flow control	●	
Attachment mode flow control		●
Engine auto idle	●	
Engine auto shutdown control		●
CAB & INTERIOR	STD	OPT
ISO Standard Cabin		
Rise-up type windshield wiper	●	
Radio / USB player	●	
Handsfree mobile phone system with USB	●	
12 V power outlet (24 V DC to 12 V DC converter)	●	
Electric horn	●	
All-weather steel cab with 360° visibility	●	
Safety glass windows	●	
Sliding fold-in front window	●	
Sliding side window (LH)	●	
Lockable door	●	
Hot & Cool box	●	
Storage compartment & Ashtray	●	
Sun visor	●	
Door and cab locks, one key	●	
Pilot-operated slidable joystick	●	
Automatic Climate Control		
Air conditioner & Heater	●	
Defroster	●	
Starting aid (air grid heater) for cold weather	●	
Centralized Monitoring		
8" LCD display - Normal type	●	
8" LCD display - Premium type		●
Engine speed or trip meter / Accel	●	
Engine coolant temperature gauge	●	
Max power	●	
Low speed / High speed	●	
Auto idle	●	
Overload	●	
Air cleaner clogging	●	
Indicators	●	
ECO gauges	●	
Fuel level gauge	●	
Hyd. oil temperature gauge	●	
Fuel warmer	●	
Warnings	●	
Communication error	●	
Low battery	●	
Clock	●	
Cabin lights		●
Cabin front window rain guard		●
Cabin roof-steel cover	●	
Seat		
Mechanical suspension without heater	●	
Mechanical suspension with heater		●
Adjustable air suspension without heater		●
Adjustable air suspension with heater		●
Cabin FOPS		
FOPS (falling object protective structures) ISO 10262 level 2	Front & Tops guard	●
	Tops guard	●
Cabin ROPS		
ROPS (roll over protective structures)ISO 12117-2		●

SAFETY	STD	OPT
Battery master switch	●	
Rearview camera		●
AAVM (advanced around view monitoring)		●
Four front working lights (2 boom mounted, 2 front frame mounted)	●	
Travel alarm	●	
Rear work lamp		●
Beacon lamp		●
Automatic swing brake	●	
Boom holding system	●	
Arm holding system	●	
Safety lock valve for boom cylinder with overload warning device		●
Safety lock valve for arm cylinder		●
Swing lock system		●
Two outside rearview mirror	●	

ATTACHMENT	STD	OPT
Booms		
5.68 m, 18' 8" mono	●	
5.68 m, 18' 8" Heavy Duty		●
8.2 m, 26' 11" long reach		●
Arms		
2.0 m, 6' 7"		●
2.4 m, 7' 10"		●
2.92 m, 9' 7"	●	
2.92 m, 9' 7" Heavy Duty		●
3.9 m, 12' 10"		●
6.3 m, 20' 8" long reach		●

OTHER	STD	OPT
Removable clean-out dust net for cooler	●	
Removable reservoir tank	●	
Fuel pre-filter	●	
Fuel warmer		●
Self-diagnostics system	●	
Hi MATE (remote management system)		●
Batteries (2 x 12 V x 100 AH)	●	
Fuel filler pump (50 L/min)		●
Single-acting piping kit (Breaker, etc.)		●
Double-acting piping kit (Clamshell, etc.)		●
Rotating piping kit		●
Quick coupler piping		●
Quick coupler		●
Accumulator for lowering work equipment	●	
Pattern change valve (4 patterns)		●
Fine swing control system		●
General type guardrail		●
Tool kit		●

COUNTERWEIGHT	STD	OPT
3.8 ton CWT	●	
4.2 ton CWT		●
5.3 ton CWT (LR)		●

UNDERCARRIAGE	STD	OPT
Lower frame under cover (additional)		●
Lower frame under cover (normal)	●	
Track Shoes		
Triple grousers shoes (600 mm, 24")	●	
Triple grousers shoe (700 mm, 28")		●
Triple grousers shoe (800 mm, 32")		●
Triple grousers shoe (900 mm, 36")		●
Double grousers shoe (600 mm, 24")		●
Double grousers shoe (700 mm, 28")		●
Track rail guard	●	
Full track rail guard		●

* Standard and optional equipment may vary. Contact your Hyundai dealer for more information.
 The machine may vary according to international standards.
 * The photos may include attachments and optional equipment that are not available in your area.
 * Materials and specifications are subject to change without advance notice.
 * All imperial measurements rounded off to the nearest pound or inch.

HYUNDAI CONSTRUCTION EQUIPMENT

Head Office (Sales office)
 First tower, 55, Bundang-ro, Bundang-gu, Seongnam-si, Gyeonggi-do, Korea

PLEASE CONTACT

www.hyundai-ce.com

2020. 09. Rev.9

MOVING YOU FURTHER

HX225S HX225S L

With Tier 2 / Stage II Engine Installed



*Photo may include optional equipment.

Net Power
 SAE J1349 / 147 HP (110 kW) at 1,950 rpm

Gross Power
 SAE J1995 / 150 HP (112 kW) at 1,950 rpm

Bucket Capacity
 0.92~1.34 m³

Operating Weight
 22,070 kg / 48,660 lb

RULE THE GROUND

The HX Series exceeds customer's expectation!
Become a true leader on the ground with HCE's HX series.

HX225S HX225S L



WORK MAX, WORTH MAX

- New Variable Power Control
- Fuel Rate Information
- IPC (Intelligent Power Control)
- Attachment Flow Control (Option)
- ECO Gauge
- New Cooling System with Increased Air Flow
- Enlarged Air Inlet with Grill Cover
- Cycle Time Improvement



MORE RELIABLE, MORE SUSTAINABLE

- Durable Cooling Module
- Reinforced Pin, Bush, and Polymer Shim
- Reinforced Durability of Upper and Lower Structure and Attachments
- Wear Resistant Cover Plate
- Hi-grade (High-pressure) Hoses



INFOTAINMENT FRONTIER

- New Front Side Air-conditioning System
- Intelligent and Wide Cluster
- New Air Conditioning System
- Proportional Auxiliary Hydraulic System (Option)
- Quick Coupler Button (Option)
- New Audio System



MODERN COMFORT, SIMPLE AND SAFE SOLUTION

- AAVM (Advanced Around View Monitoring) Camera System (Option)
- Hi MATE (Remote Management System) (Option)
- Cab Suspension Mount
- Swing Lock System (Option)
- Fine Swing Control (Option)



*Photo may include optional equipment.

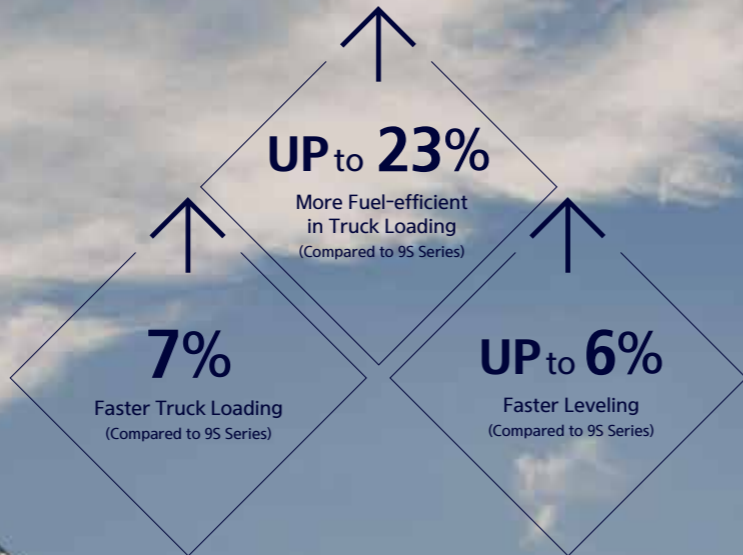

Photo may include optional equipment.

New Variable Power Control

The HX Series minimizes equipment input and output control signals to improve fuel efficiency. Its three-stage power mode ensures the highest performance in any operating environment.



* **P(power) mode** : Maximizes speed and power of the equipment for heavy load work.



* **S(standard) mode** : Optimizes performance and fuel efficiency of the equipment for general load work.



* **E(economy) mode** : Improves the control system for light load work.

WORK MAX, WORTH MAX

Fuel Efficient System, Allows Great Performance

The HX Series has an eco-friendly, high-performance engine which ensures both excellent fuel efficiency and high power. With outstanding operating performance proven by rigorous tests at various work sites, it will satisfy any customer's needs.

15% increased greater screen from 7 to 8 inch is applied in HX Series. More functions and better resolution are available with adding premium options.



Fuel Rate Information (Option)

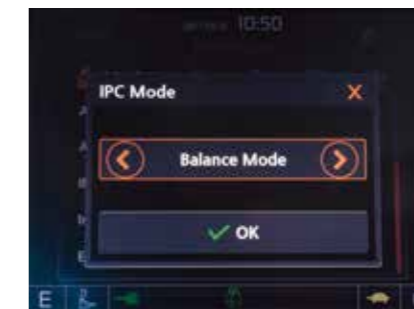

IPC (Intelligent Power Control)

The IPC controls power depending on work environments. Its mode can be selected and released on the monitor. On the excavation mode, pump flow can be easily controlled by a lever, reducing fuel consumption.



Attachment Flow Control (Option)

The HX Series improves pump flow rate by independent control of two pumps. It optimizes attachments for effective flow rate setting depending on attachments (ten breaker types and ten crusher types), enabling various operations matching the site environments.



Eco Gauge

Eco gauge enables economic operation of machines. The gauge level and color displays engine torque and fuel efficiency level. On top of that, the status of fuel consumption such as average rate and the total amount of fuel consumed is displayed. Hourly and daily based fuel consumption can be checked in the detailed menu as well.



New Cooling System with Increased Air Flow

With the three-floor horizontally placed cooling module improving air inflow, the HX Series provides excellent cooling performance by increasing heat dissipation and can be easily cleaned.



Enlarged Air Inlet with Grill Cover

Enlarged vent hole of the air inlet side cover and fine net grill to prevent penetration of foreign materials further improve durability.

Cycle Time Improvement

The HX Series provides higher productivity on the site by faster operation: it loads trucks up to 7% faster and levels up to 6% faster than the 9S Series.

MORE RELIABLE, MORE SUSTAINABLE

New Exterior Design for Robustness and Safety

The true value of the HX Series lies in its durability. The robust frame structure and the attachments show the real value of the HX Series in tough working environments and promise higher productivity.



Durable Cooling Module

The HX Series has a durable cooling module that passed stringent tests, demonstrating the highest productivity in tough working environments.



Chrome Coated Pins

Reinforced Pin, Bush, and Polymer Shim

The HX Series improves lubricity of connecting parts between the equipment and attachments. Gaps with attachments are minimized by wear-resistant long-life pins, bushes, and polymer shims, supporting the highest performance with invariable durability.

Wear Resistant Cover Plate

A wear-resistant cover plate is installed at the end of the arm to minimize abrasion on the connector between the arm and the bucket. Vibration reduction of buckets enables more stable operation even in high-load work.



Reinforced Durability of Upper and Lower Structure and Attachments

The upper and lower structure and attachments of the HX Series have higher durability than demanded on the site, as proven through numerous tests including road tests and virtual simulation. The wear resistance of the bucket has been improved by use of new material.



*Photo may include optional equipment

Hi-grade (High-pressure) Hoses

The HX Series uses high-pressure hoses with improved heat and pressure resistance, greatly increasing the durability of the equipment.



310 mm
(9S Series)

340 mm
(HX Series)

Cabin space for drivers increased by
13%
(Compared to 9S Series)

*Photo may include optional equipment.

INFOTAINMENT FRONTIER

Improved Instrument Panel for Easier Monitoring

Many electronic functions are concentrated in the most convenient spot for operators to improve work efficiency. The highly-advanced infotainment system, a product of HCE's intensive information technology development, enables both productivity and comfort while working! The HX Series is designed with the operator in mind.



Intelligent and Wide Cluster

The 8-inch interactive touchscreen display of the HX Series is 15% larger than that of the previous model. The centralized switches on the display allow the operator to check the urea level and the temperature outside the cab.



New Air Conditioning System

Front side Air Vent holes make operators more convenient and fresh through direct air flow to driver's face, foot and body.



Proportional Auxiliary Hydraulic System (Option)

- Proportional control switch for better speed control
- Enlarge the operation convenience



Front Side Air-Vent

Quick Coupler Button (Option)

Easy attachment replacement of equipment is available with quick coupler button.

New Audio System

The radio player with a USB-based MP3 player, an integrated Bluetooth hands-free feature, and a built-in microphone allow for phone calls while at work and in transit. The radio player is conveniently located on the right side of the operator to allow for improved access.



New Front Side Air-conditioning System

The ventilation is designed for both warm and cool air reaching to operators' faces. It could help operators create more neat and enjoyable atmosphere through indoor air circulation.

MODERN COMFORT, SIMPLE AND SAFE SOLUTION

New Cabin for More Comfort

Low noise, low vibration, and ergonomic design make the cabin space more comfortable and pleasant! With focus on safety and convenience of operators, the HX Series allows rapid and safe equipment inspection anytime and anywhere, providing an optimal environment for operators to work.



AAVM (Advanced Around View Monitoring) Camera System **Option**

The HX Series has a state-of-the-art AAVM video camera system to secure field of vision for operators in all directions, thereby preventing accidents. Operators can easily check the workplace in the front and rear and to the right and left.



*AVM (Around View Monitoring): Secure field of vision in all directions by nine views including 3D bird's eye view and 2D/4CH view.

*IMOD (Intelligent Moving Object Detection): Inform when people or dangerous objects are detected within the range of operation (Recognition distance: 5m).

HiMATE

It's Convenient, Easy and Valuable

Hi MATE Hyundai's newly developed remote management system, utilizes GPS-satellite technology to provide customers with the highest level of service and product support available. Hi MATE enables users to remotely evaluate machine performance, access diagnostic information, and verify machine locations at the touch of a button.

What is benefits



Increase Productivity

It helps you operate machines in efficient. You can check the difference between total engine hours and actual working hours. See how productive your machines are and plan any required cost saving solutions. Hi MATE offers working information such as working / idling hours, fuel consumption and rate.



Convenient and Easy Monitoring

There is nothing much to do to monitor your machines. Just log on to the Hi MATE website or mobile application. Hi MATE allows you to watch your machines whenever and wherever you are.



Security

Protect your machines from theft or unauthorized usage with Hi MATE. If the machine moves out of the Geo-fence boundary, you will get alerts.



*Photo may include optional equipment.

Cab Suspension Mount

With a low-vibration design by the coil spring and damper inside the mount, the cab suspension mount of the HX Series reduces noise inside the cabin and improves durability, providing a comfortable operation space that lessens operators' fatigue.

Swing Lock System (Option)

Swing lock system is provided to maintain stability when swing movement needs to be limited, improving operating speed and productivity.

Fine Swing Control (Option)

Fine swing control is available for customer's convenience when users want to control fine swing.

SPECIFICATIONS

ENGINE

Maker / Model	HYUNDAI HM5.9	
Type	Water cooled 4 cycle diesel, 6 cylinders in line, direct injection, turbocharged, charger air, cooled, low emission	
Rated flywheel horse power	SAE J1995 (gross)	150 HP (112 kW) at 1,950 rpm
	J1349 (net)	147 HP (110 kW) at 1,950 rpm
DIN	6271 / 1 (gross)	152 PS (112 kW) at 1,950 rpm
	6271 / 1 (net)	149 PS (110 kW) at 1,950 rpm
Max. torque	62.6 kgf · m (450 lbf · ft) at 1,500 rpm	
Bore X stroke	102 × 120 mm (4.02" × 4.72")	
Piston displacement	5900 cc (359 cu in)	
Batteries	2 × 12 V × 100 Ah	
Starting motor	24 V × 4.8 kW	
Alternator	24 V × 95 A	

HYDRAULIC SYSTEM

MAIN PUMP	
Type	Variable displacement tandem axis piston pumps
Max. flow	2 × 247 l/min
Sub-pump for pilot circuit	Gear pump

Cross-sensing and fuel saving pump system

HYDRAULIC MOTORS	
Travel	Two speed axial pistons motor with brake valve and parking brake
Swing	Axial piston motor with automatic brake

RELIEF VALVE SETTING

Implement circuits	350 kgf/cm ² (4,980 psi)
Travel	350 kgf/cm ² (4,980 psi)
Power boost (boom, arm, bucket)	380 kgf/cm ² (5,400 psi)
Swing circuit	265 kgf/cm ² (3,770 psi)
Pilot circuit	40 kgf/cm ² (570 psi)
Service valve	Installed

HYDRAULIC CYLINDERS

No. of cylinder bore X stroke	Boom: 2-∅120 × 1,290 mm Arm: 1-∅140 × 1,510 mm Bucket: 1-∅120 × 1,055 mm
-------------------------------	--

DRIVES & BRAKES

Drive method	Fully hydrostatic type
Drive motor	Axial piston motor, in-shoe design
Reduction system	Planetary reduction gear
Max. drawbar pull	21,100 kgf (46,517 lbf)
Max. travel speed (high / low)	5.4 km/hr (3.35 mph) / 3.6 km/hr (2.23 mph)
Gradeability	35° (70%)
Parking brake	Multi wet disc

CONTROL

Pilot pressure operated joysticks and pedals with detachable lever provide almost effortless and fatigueless operation.	
Pilot control	Two joysticks with one safety lever (LH): Swing and arm, Boom and bucket
Traveling and steering	Two levers with pedals
Engine throttle	Electric, dial type

SWING SYSTEM

Swing motor	Fixed displacement axial piston motor
Swing reduction	Planetary gear reduction
Swing bearing lubrication	Grease-bathed
Swing brake	Multi wet disc
Swing speed	12.5 rpm

COOLANT & LUBRICANT CAPACITY

	liter	US gal	UK gal
Fuel tank	400	106	88
Engine coolant	31	8.2	6.82
Engine oil	20	5.3	4.4
Swing device	6.2	1.64	1.36
Final drive (each)	4.5	1.2	1
Hydraulic system (including tank)	275	72.6	60.5
Hydraulic tank	160	42.3	35.2

UNDERCARRIAGE

The X-leg type center frame is integrally welded with reinforced box-section track frames. The undercarriage includes lubricated rollers, idlers, track adjusters with shock absorbing springs and sprockets, and a track chain with double or triple grouser shoes.

model	HX225SL	HX225S
Center frame	X-leg type	X-leg type
Track frame	Pentagonal box type	Pentagonal box type
No. of shoes on each side	49 EA	46 EA
No. of carrier roller on each side	2 EA	2 EA
No. of track roller on each side	9 EA	7 EA
No. of rail guard on each side	2 EA	1 EA

OPERATING WEIGHT (APPROXIMATE)

Operating weight, including 5,680 mm (18' 8") boom, 2,920 mm (9' 7") arm, SAE heaped 0.92 m³ (1.20 yd³) bucket, lubricant, coolant, full fuel tank, full hydraulic tank, and all standard equipments.







OPERATING WEIGHT

Shoes	Operating weight		Ground pressure	
	Width mm (in)	kg (lb)		
600 (24")	HX225S	21,700 (47,840)	0.50 (7.10)	
	HX225S L	22,070 (48,660)	0.47 (6.70)	
	HX225S L HW	24,030 (53,570)	0.52 (7.38)	
	HX225S	21,970 (48,440)	0.43 (6.16)	
	700 (28")	HX225S L	22,550 (49,710)	0.41 (5.87)
		HX225S L HW	24,580 (54,190)	0.45 (6.40)
HX225S		22,240 (49,030)	0.38 (5.45)	
Triple grouser	HX225S L	22,830 (50,330)	0.37 (5.20)	
	HX225S L LR	24,830 (54,740)	0.40 (5.65)	
	HX225S L HW	24,860 (54,810)	0.40 (5.66)	
	HX225S L	23,150 (51,040)	0.33 (4.68)	
900 (36")	HX225S L HW	25,180 (55,510)	0.36 (5.10)	
	HX225S L HW	24,530 (54,080)	0.52 (7.44)	
Double grouser	HX225S L HW	24,850 (54,780)	0.45 (6.46)	

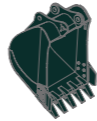
BUCKET SELECTION GUIDE & DIGGING FORCE

BUCKETS

All buckets are welded with high-strength steel.

						
SAE heaped m ³ (yd ³)	0.92 (1.20)	1.10 (1.44)	1.34 (1.75)	◆0.90 (1.18) ◆1.05 (1.37)	◎0.87 (1.14) ◎1.20 (1.57)	★0.52 (0.68)

Capacity m ³ (yd ³)	Width mm (in)	Weight kg (lb)	Tooth EA	Recommendation mm (ft-in)							
				5,680 (18' 8") Boom					8,200 (26' 11") Boom		
				3.8 ton CWT			4.2 ton CWT		5.3 ton CWT		
SAE heaped	CECE heaped			2,000 (6' 7") Arm	2,400 (7' 10") Arm	2,920 (9' 7") Arm	2,000 (9' 7") Arm	2,400 (7' 10") Arm	2,920 (9' 7") Arm	3,900 (12' 10") Arm	6,300 (20' 8") Arm
0.92 (1.20)	0.80 (1.05)	1,150 (45.3")	770 (1,700)	5	●	●	●	●	●	●	-
1.10 (1.44)	0.96 (1.26)	1,320 (52.0")	830 (1,830)	5	●	●	■	●	●	●	-
1.20 (1.57)	1.00 (1.31)	1,400 (55.1")	850 (1,870)	5	●	●	■	●	●	●	-
1.34 (1.75)	1.15 (1.50)	1,550 (61.0")	920 (2,030)	6	■	■	▲	●	■	▲	-
◆0.90 (1.18)	0.80 (1.05)	1,095 (43.1")	810 (1,790)	5	●	●	●	●	●	■	-
◆1.05 (1.37)	0.92 (1.20)	1,290 (50.8")	890 (1,960)	5	●	●	■	●	●	●	-
◎0.87 (1.14)	0.75 (0.98)	1,140 (44.9")	900 (1,980)	5	●	●	●	●	●	-	-
◎1.20 (1.57)	1.00 (1.31)	1,410 (55.5")	1,030 (2,270)	5	●	■	▲	●	●	■	-
★0.52 (0.68)	0.45 (0.59)	935 (36.8")	460 (1,010)	5	-	-	-	-	-	-	■

- ◆ Heavy duty bucket
- ◎ Rock-Heavy duty bucket
- ★ Long reach bucket

- : Applicable for materials with density of 2,100 kg/m³ (3,500 lb/yd³) or less
- ◎ : Applicable for materials with density of 1,800 kg/m³ (3,000 lb/yd³) or less
- : Applicable for materials with density of 1,500 kg/m³ (2,500 lb/yd³) or less
- ▲ : Applicable for materials with density of 1,200 kg/m³ (2,000 lb/yd³) or less
- : Not Recommended

ATTACHMENT

Booms and arms are welded with a low-stress, full-box section design. 5.68 m, 8.2 m booms and 2.0 m, 2.4 m, 2.92 m, 3.9 m & 6.3 m arms are available.

DIGGING FORCE

Boom	Length	mm (ft-in)	5,680 (18' 8")				8,200 (26' 11")		Remark
			kg (lb)		1,950 (4,300)		2,350 (5,180)		
Arm	Length	mm (ft-in)	2,000 (6' 7")	2,400 (7' 10")	2,920 (9' 7")	3,900 (12' 10")	6,300 (20' 8")		
			kg (lb)		975 (2,150)	1,045 (2,300)	1,095 (2,410)	1,295 (2,850)	1,330 (2,930)
Bucket digging force	SAE	kN	133.4 [144.8]	133.4 [144.8]	133.4 [144.8]	133.4 [144.8]	72.6		
		kgf	13,600 [14,770]	13,600 [14,770]	13,600 [14,770]	13,600 [14,770]	7,400		
		lbf	29,980 [32,550]	29,980 [32,550]	29,980 [32,550]	29,980 [32,550]	16,310		
	ISO	kN	152.0 [165.0]	152.0 [165.0]	152.0 [165.0]	152.0 [165.0]	83.4		
		kgf	15,500 [16,830]	15,500 [16,830]	15,500 [16,830]	15,500 [16,830]	8,500		
		lbf	34,170 [37,100]	34,170 [37,100]	34,170 [37,100]	34,170 [37,100]	18,740		
Arm crowd force	SAE	kN	144.2 [156.5]	119.6 [129.9]	102.0 [110.7]	84.3 [91.6]	49.0		
		kgf	14,700 [15,960]	12,200 [13,250]	10,400 [11,290]	8,600 [9,340]	5,000		
		lbf	32,410 [35,190]	26,900 [29,210]	22,930 [24,900]	18,960 [20,590]	11,020		
	ISO	kN	151.0 [164.0]	125.5 [136.3]	106.9 [116.1]	87.3 [94.8]	50.0		
		kgf	15,400 [16,720]	12,800 [13,900]	10,900 [11,830]	8,900 [9,660]	5,100		
		lbf	33,950 [36,860]	28,220 [30,640]	24,030 [26,090]	19,620 [21,300]	11,240		

Note: Boom weight includes arm cylinder, piping, and pin
Arm weight includes bucket cylinder, linkage, and pin

DIMENSIONS & WORKING RANGE

HX225S DIMENSIONS

5.68 m (18' 8") boom and 2.0 m (6' 7"), 2.4 m (7' 10"), 2.92 m (9' 7"), 3.9 m (12' 10") arm

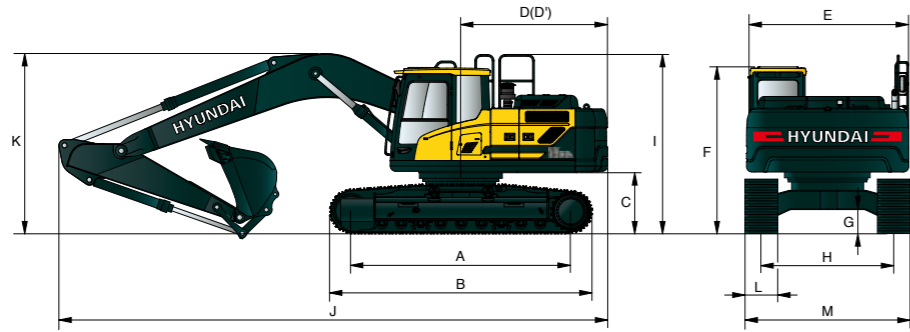

Unit : mm (ft - in)

A	Tumbler distance	3,360 (11' 0")
B	Overall length of crawler	4,114 (13' 6")
C	Ground clearance of counterweight	1,060 (3' 6")
D	Tail swing radius	2,890 (9' 5")
D'	Rear-end length	2,770 (9' 1")
E	Overall width of upperstructure	2,740 (9' 0")
F	Overall height of cab	3,030 (9' 11")
G	Min. ground clearance	480 (1' 7")
H	Track gauge	2,200 (7' 3")
I	Overall height of handrail (Option)	3,213 (10' 6")

Boom length	5,680 (18' 8")			
Arm length	2,000 (6' 7")	2,400 (7' 10")	2,920 (9' 7")	3,900 (12' 10")
J Overall length	9,650 (31' 8")	9,570 (31' 5")	9,530 (31' 3")	9,520 (31' 3")
K Overall height of boom	3,200 (10' 6")	3,110 (10' 2")	3,030 (9' 11")	3,480 (11' 5")
L Track shoe width	600 (24")	700 (28")	800 (32")	900 (36")
M Overall width	2,800 (9' 2")	2,900 (9' 6")	3,000 (9' 10")	3,100 (10' 2")

HX225S WORKING RANGE

Unit : mm (ft - in)

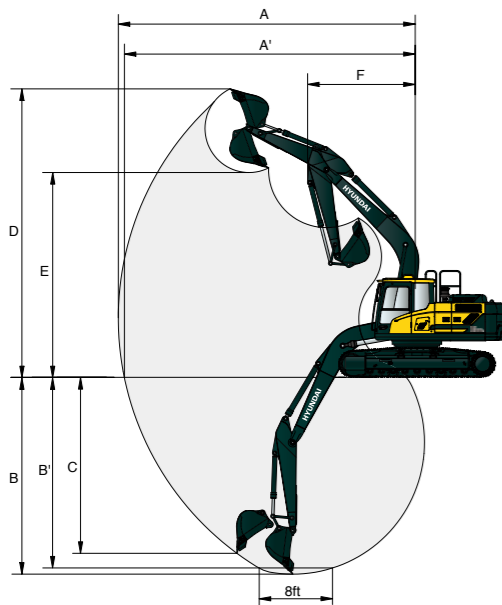

Boom length	5,680 (18' 8")			
Arm length	2,000 (6' 7")	2,400 (7' 10")	2,920 (9' 7")	3,900 (12' 10")
A Max. digging reach	9,140 (30' 0")	9,500 (31' 2")	9,980 (32' 9")	10,910 (35' 10")
A' Max. digging reach on ground	8,960 (29' 5")	9,330 (30' 7")	9,820 (32' 3")	10,770 (35' 4")
B Max. digging depth	5,820 (19' 1")	6,220 (20' 5")	6,730 (22' 1")	7,720 (25' 4")
B' Max. digging depth (8' level)	5,580 (18' 4")	6,010 (19' 9")	6,560 (21' 6")	7,580 (24' 10")
C Max. vertical wall digging depth	5,280 (17' 4")	5,720 (18' 9")	6,280 (20' 7")	7,240 (23' 9")
D Max. digging height	9,140 (30' 0")	9,340 (30' 8")	9,600 (31' 6")	10,110 (33' 2")
E Max. dumping height	6,330 (20' 9")	6,520 (21' 5")	6,780 (22' 3")	7,290 (23' 11")
F Min. swing radius	3,750 (12' 4")	3,740 (12' 3")	3,740 (12' 3")	3,650 (12' 0")

HX225S L DIMENSIONS

5.68 m (18' 8") boom and 2.0 m (6' 7"), 2.4 m (7' 10"), 2.92 m (9' 7"), 3.9 m (12' 10") arm

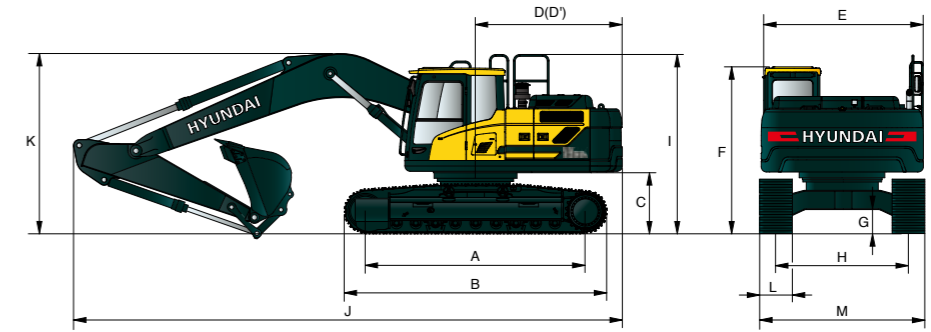

Unit : mm (ft - in)

A	Tumbler distance	3,650 (12' 0")
B	Overall length of crawler	4,404 (14' 4")
C	Ground clearance of counterweight	1,060 (3' 6")
D	Tail swing radius	2,890 (9' 5")
D'	Rear-end length	2,770 (9' 1")
E	Overall width of upperstructure	2,740 (9' 0")
F	Overall height of cab	3,030 (9' 11")
G	Min. ground clearance	480 (1' 7")
H	Track gauge	2,390 (7' 10")
I	Overall height of handrail (Option)	3,213 (10' 6")

Boom length	5,680 (18' 8")			
Arm length	2,000 (6' 7")	2,400 (7' 10")	2,920 (9' 7")	3,900 (12' 10")
J Overall length	9,650 (31' 8")	9,570 (31' 5")	9,530 (31' 3")	9,520 (31' 3")
K Overall height of boom	3,200 (10' 6")	3,110 (10' 2")	3,030 (9' 11")	3,480 (11' 5")
L Track shoe width	600 (24")	700 (28")	800 (32")	900 (36")
M Overall width	2,990 (9' 10")	3,090 (10' 2")	3,190 (10' 6")	3,290 (10' 10")

HX225S L WORKING RANGE

Unit : mm

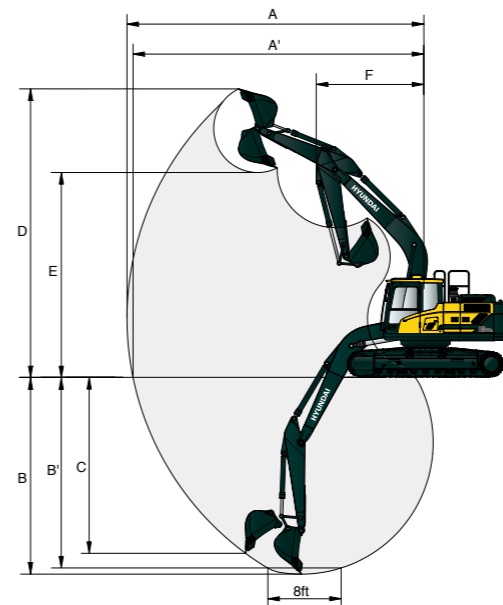

Boom length	5,680 (18' 8")			
Arm length	2,000 (6' 7")	2,400 (7' 10")	2,920 (9' 7")	3,900 (12' 10")
A Max. digging reach	9,140 (30' 0")	9,500 (31' 2")	9,980 (32' 9")	10,910 (35' 10")
A' Max. digging reach on ground	8,960 (29' 5")	9,330 (30' 7")	9,820 (32' 3")	10,770 (35' 4")
B Max. digging depth	5,820 (19' 1")	6,220 (20' 5")	6,730 (22' 1")	7,720 (25' 4")
B' Max. digging depth (8' level)	5,580 (18' 4")	6,010 (19' 9")	6,560 (21' 6")	7,580 (24' 10")
C Max. vertical wall digging depth	5,280 (17' 4")	5,720 (18' 9")	6,280 (20' 7")	7,240 (23' 9")
D Max. digging height	9,140 (30' 0")	9,340 (30' 8")	9,600 (31' 6")	10,110 (33' 2")
E Max. dumping height	6,330 (20' 9")	6,520 (21' 5")	6,780 (22' 3")	7,290 (23' 11")
F Min. swing radius	3,750 (12' 4")	3,740 (12' 3")	3,740 (12' 3")	3,650 (12' 0")

DIMENSIONS & WORKING RANGE

HX225S L LONG REACH

8.2 m (26' 11") boom and 6.3 m (20' 8") arm

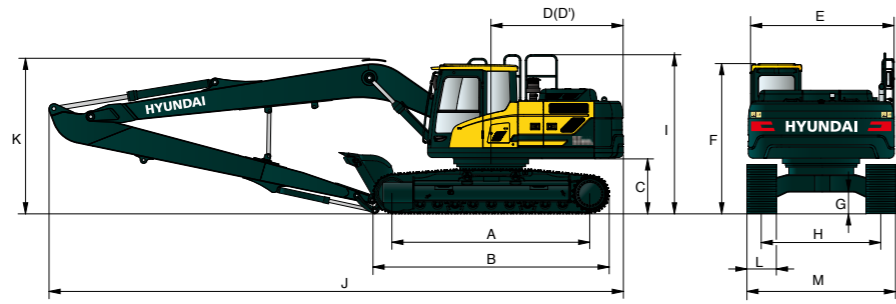

Unit : mm (ft · in)

A	Tumbler distance	3,650 (12' 0")
B	Overall length of crawler	4,404 (14' 4")
C	Ground clearance of counterweight	1,060 (3' 6")
D	Tail swing radius	2,890 (9' 5")
D'	Rear-end length	2,770 (9' 1")
E	Overall width of upperstructure	2,740 (9' 0")
F	Overall height of cab	3,030 (9' 11")
G	Min. ground clearance	480 (1' 7")
H	Track gauge	2,390 (7' 10")
I	Overall height of guardrail (Option)	3,213 (10' 6")

Boom length	8,200 (26' 11")	
Arm length	6,300 (20' 8")	
J	Overall length	12,030 (39' 6")
K	Overall height of boom	3,280 (10' 9")
L	Track shoe width	800 (32")
M	Overall width	3,190 (10' 6")

HX225S L LONG REACH WORKING RANGE

Unit : mm (ft · in)

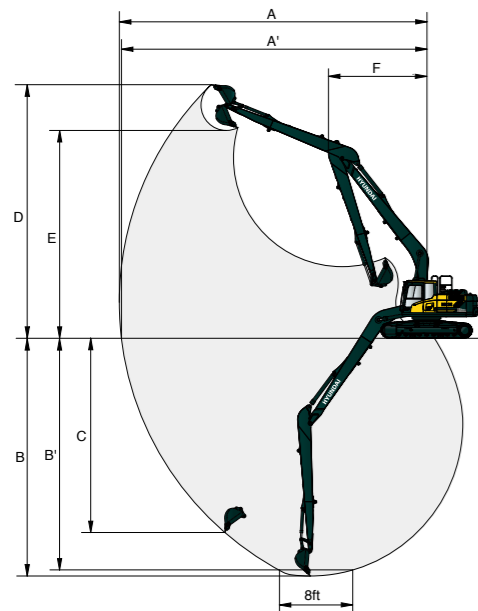

Boom length	8,200 (26' 11")	
Arm length	6,300 (20' 8")	
A	Max. digging reach	15,220 (50' 0")
A'	Max. digging reach on ground	15,120 (49' 7")
B	Max. digging depth	11,760 (38' 7")
B'	Max. digging depth (8' level)	11,650 (38' 3")
C	Max. vertical wall digging depth	9,610 (31' 6")
D	Max. digging height	12,550 (41' 2")
E	Max. dumping height	10,280 (33' 8")
F	Min. swing radius	4,870 (16' 0")

HX225S L HIGH WALKER DIMENSIONS

5.68 m (18' 8") boom and 2.0 m (6' 7"), 2.4 m (7' 10"), 2.92 m (9' 7"), 3.9 m (12' 10") arm

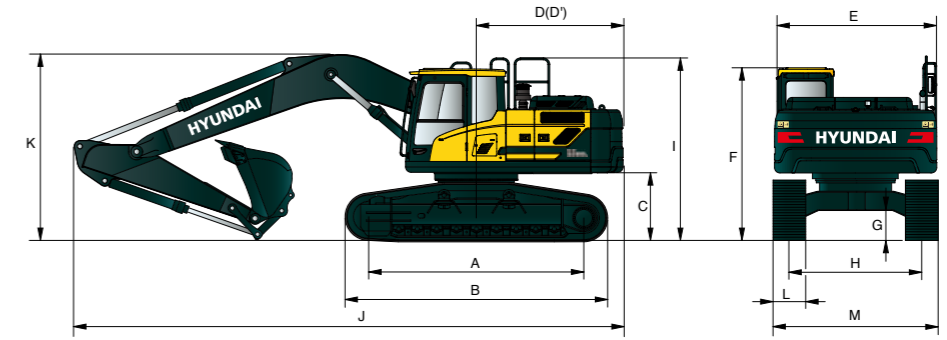

Unit : mm (ft · in)

A	Tumbler distance	3,650 (12' 0")
B	Overall length of crawler	4,404 (14' 4")
C	Ground clearance of counterweight	1,260 (4' 1")
D	Tail swing radius	2,890 (9' 5")
D'	Rear-end length	2,770 (9' 1")
E	Overall width of upperstructure	2,740 (9' 0")
F	Overall height of cab	3,230 (10' 7")
G	Min. ground clearance	660 (2' 2")
H	Track gauge	2,795 (9' 2")
I	Overall height of handrail (Option)	3,413 (11' 2")

Boom length	5,680 (18' 8")						
Arm length	2,000 (6' 7")	2,400 (7' 07")	2,920 (9' 7")	3,900 (12' 10")			
J	Overall length	9,650 (31' 8")	9,550 (31' 4")	9,470 (31' 1")	9,560 (31' 4")		
K	Overall height of boom	3,290 (10' 10")	3,170 (10' 5")	3,060 (10' 0")	3,450 (11' 4")		
L	Track shoe	Triple grouser		Double grouser			
	width	600 (24")	700 (28")	800 (32")	900 (36")	600 (24")	700 (28")
M	Overall width	3,395 (11' 2")	3,495 (11' 6")	3,595 (11' 10")	3,695 (12' 2")	3,395 (11' 2")	3,495 (11' 6")

HX225S L HIGH WALKER WORKING RANGE

Unit : mm (ft · in)

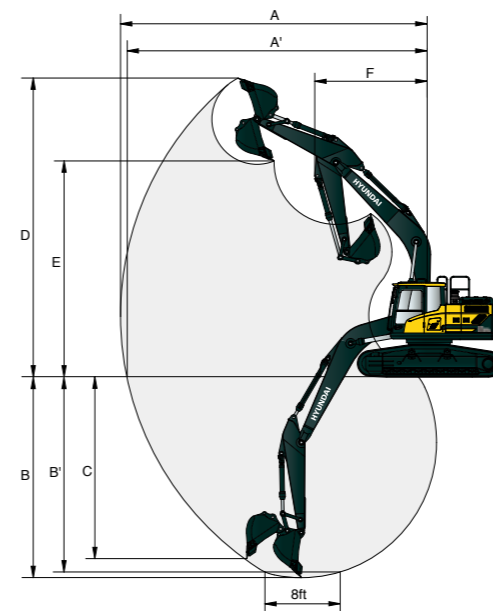













Boom length	5,680 (18' 8")				
Arm length	2,000 (6' 7")	2,400 (7' 07")	2,920 (9' 7")	3,900 (12' 10")	
A	Max. digging reach	9,140 (30' 0")	9,500 (31' 2")	9,980 (32' 9")	10,910 (35' 10")
A'	Max. digging reach on ground	8,920 (29' 3")	9,290 (30' 6")	9,820 (32' 3")	10,730 (35' 2")
B	Max. digging depth	5,630 (18' 6")	6,010 (19' 9")	6,550 (21' 6")	7,530 (24' 8")
B'	Max. digging depth (8' level)	5,390 (17' 8")	5,820 (19' 1")	6,380 (20' 11")	7,390 (24' 3")
C	Max. vertical wall digging depth	5,090 (16' 8")	5,630 (18' 6")	6,100 (20' 0")	7,050 (23' 1")
D	Max. digging height	9,330 (30' 7")	9,530 (31' 3")	9,780 (32' 1")	10,300 (33' 9")
E	Max. dumping height	6,520 (21' 5")	6,710 (22' 0")	6,960 (22' 10")	7,480 (24' 6")
F	Min. swing radius	3,750 (12' 4")	3,740 (12' 3")	3,740 (12' 3")	3,650 (12' 0")

LIFTING CAPACITY

 Rating over-front  Rating over-side or 360 degree

HX225S L

5.68 m (18' 8") boom, 2.92 m (9' 7") arm equipped with 600 mm (24") triple grouser shoe, and 3,800 kg (8,380 lb) counterweight.











Load point height m (ft)	Load radius										At max. reach			
	1.5 m (4.9 ft)		3.0 m (9.8 ft)		4.5 m (14.8 ft)		6.0 m (19.7 ft)		7.5 m (24.6 ft)		Capacity	Reach		
													m (ft)	
7.5 m 24.6 ft	kg							*4,430	*4,430			*3,370	*3,370	6.27
	lb							*9,770	*9,770			*7,430	*7,430	(20.6)
6.0 m 19.7 ft	kg							*4,340	*4,340			*3,090	*3,090	7.39
	lb							*9,570	*9,570			*6,810	*6,810	(24.2)
4.5 m 14.8 ft	kg							*4,860	4,450	*4,640	3,110	*3,020	2,730	8.07
	lb							*10,710	9,810	*10,230	6,860	*6,660	6,020	(26.5)
3.0 m 9.8 ft	kg				*7,280	6,450	*5,710	4,220	4,660	3,010		*3,070	2,490	8.43
	lb				*16,050	14,220	*12,590	9,300	10,270	6,640		*6,770	5,490	(27.7)
1.5 m 4.9 ft	kg				*9,060	5,980	6,340	4,000	4,550	2,910		*3,250	2,410	8.51
	lb				*19,970	13,180	13,980	8,820	10,030	6,420		*7,170	5,310	(27.9)
0.0 m 0.0 ft	kg			*5,950	*5,950	9,650	5,760	6,180	3,860	4,480	2,840	*3,590	2,470	8.32
	lb			*13,120	*13,120	21,270	12,700	13,620	8,510	9,880	6,260	*7,910	5,450	(27.3)
-1.5 m -4.9 ft	kg	*6,530	*6,530	*10,430	*10,430	9,620	5,720	6,140	3,820	4,470	2,830	*4,210	2,690	7.84
	lb	*14,400	*14,400	*22,990	*22,990	21,210	12,610	13,540	8,420	9,850	6,240	*9,280	5,930	(25.7)
-3.0 m -9.8 ft	kg	*11,150	*11,150	*14,280	11,210	9,740	5,830	6,210	3,880			5,030	3,200	7.00
	lb	*24,580	*24,580	*31,480	24,710	21,470	12,850	13,690	8,550			11,090	7,050	(23.0)
-4.5 m -14.8 ft	kg			*11,760	11,650	*8,270	6,090					*6,160	4,470	5.64
	lb			*25,930	25,680	*18,230	13,430					*13,580	9,850	(18.5)

- Lifting capacity are based on ISO 10567.
- Lifting capacity of the ROBEX series does not exceed 75% of tipping load with the machine on firm, level ground or 87% of full hydraulic capacity.
- The load point is a hook located on the back of the bucket.
- (*) indicates load limited by hydraulic capacity.











 Rating over-front  Rating over-side or 360 degree

HX225S L

5.68 m (18' 8") boom, 2.00 m (6' 7") arm equipped with 600 mm (24") triple grouser shoe, and 3,800 kg (8,380 lb) counterweight.

Load point height m (ft)	Load radius										At max. reach							
	3.0 m (9.8 ft)		4.5 m (14.8 ft)		6.0 m (19.7 ft)		7.5 m (24.6 ft)		Capacity	Reach								
											m (ft)							
7.5 m 24.6 ft	kg																	
	lb																	
6.0 m 19.7 ft	kg									*4,350	*4,350		*4,400	3,990	6.45			
	lb									*9,590	*9,590		*9,700	8,800	(21.2)			
4.5 m 14.8 ft	kg									*5,570	*5,570	*4,760	4,370		*4,540	3,160	7.23	
	lb									*12,280	*12,280	*10,490	9,630		*10,010	6,970	(23.7)	
3.0 m 9.8 ft	kg									*7,350	6,470	*5,520	4,120	4,730	2,850	4,600	2,770	7.63
	lb									*16,200	14,260	*12,170	9,080	10,430	6,280	10,140	6,110	(25.0)
1.5 m 4.9 ft	kg									*8,930	6,040	*6,310	3,900	4,630	2,750	4,420	2,630	7.72
	lb									*19,690	13,320	*13,910	8,600	10,210	6,060	9,740	5,800	(25.3)
0.0 m 0.0 ft	kg									*9,660	5,900	6,460	3,780	4,570	2,710	4,560	2,700	7.51
	lb									*21,300	13,010	14,240	8,330	10,080	5,970	10,050	5,950	(24.7)
-1.5 m -4.9 ft	kg	*13,200	12,220	*9,610	5,920	6,460	3,780									5,130	3,040	6.97
	lb	*29,100	26,940	*21,190	13,050	14,240	8,330									11,310	6,700	(22.9)
-3.0 m -9.8 ft	kg	*12,550	12,450	*8,810	6,090	*6,330	3,920									*6,300	3,910	6.02
	lb	*27,670	27,450	*19,420	13,430	*13,960	8,640									*13,890	8,620	(19.7)
-4.5 m -14.8 ft	kg															*6,770	*6,770	4.36
	lb															*14,930	*14,930	

5.68 m (18' 8") boom, 2.40 m (7' 10") arm equipped with 600 mm (24") triple grouser shoe, and 3,800 kg (8,380 lb) counterweight.

Load point height m (ft)	Load radius										At max. reach							
	3.0 m (9.8 ft)		4.5 m (14.8 ft)		6.0 m (19.7 ft)		7.5 m (24.6 ft)		Capacity	Reach								
											m (ft)							
7.5 m 24.6 ft	kg												*3,550	*3,550	5.77			
	lb												*7,830	*7,830	(18.9)			
6.0 m 19.7 ft	kg									*3,900	*3,900		*3,290	*3,290	6.97			
	lb									*8,600	*8,600		*7,250	*7,250	(22.9)			
4.5 m 14.8 ft	kg									*4,370	*4,370	*4,170	2,960	*3,270	2,810	7.70		
	lb									*9,630	*9,630	*9,190	6,530	*7,210	6,190	(25.3)		
3.0 m 9.8 ft	kg									*6,770	6,570	*5,170	4,140	*4,490	2,840	*3,430	2,490	8.08
	lb									*14,930	14,480	*11,400	9,130	*9,900	6,260	*7,560	5,490	(26.5)
1.5 m 4.9 ft	kg									*8,480	6,080	*6,040	3,900	4,600	2,720	*3,770	2,360	8.16
	lb									*18,700	13,400	*13,320	8,600	10,140	6,000	*8,310	5,200	(26.8)
0.0 m 0.0 ft	kg	*6,850	*6,850	*9,450	5,860	6,430	3,750	4,520	2,650					4,120	2,420	4,120	2,420	7.97
	lb	*15,100	*15,100	*20,830	12,920	14,180	8,270	9,960	5,840					9,080	5,340	9,080	5,340	(26.1)
-1.5 m -4.9 ft	kg	*11,830	*11,830	*9,640	5,840	6,390	3,710							4,560	2,680	4,560	2,680	7.46
	lb	*26,080	*26,080	*21,250	12,870	14,090	8,180							10,050	5,910	10,050	5,910	(24.5)
-3.0 m -9.8 ft	kg	*13,290	12,220	*9,080	5,970	6,490	3,800							5,640	3,330	5,640	3,330	6.57
	lb	*29,300	26,940	*20,020	13,160	14,310	8,380							12,430	7,340	12,430	7,340	(21.6)
-4.5 m -14.8 ft	kg	*10,650	*10,650	*7,360	6,270									*6,270	5,160	*6,270	5,160	5.11
	lb	*23,480	*23,480	*16,230	13,820									*13,820	11,380	*13,820	11,380	(16.8)











- Lifting capacity are based on ISO 10567.
- Lifting capacity of the ROBEX series does not exceed 75% of tipping load with the machine on firm, level ground or 87% of full hydraulic capacity.
- The load point is a hook located on the back of the bucket.
- (*) indicates load limited by hydraulic capacity.

LIFTING CAPACITY

 Rating over-front  Rating over-side or 360 degree

HX225S L

5.68 m (18' 8") boom, 3.9 m (12' 10") arm equipped with 600 mm (24") triple grouser shoe, and 3,800 kg (8,380 lb) counterweight.











Load point height m (ft)	Load radius										At max. reach			
	1.5 m (4.9 ft)		3.0 m (9.8 ft)		4.5 m (14.8 ft)		6.0 m (19.7 ft)		7.5 m (24.6 ft)		Capacity	Reach		
												m (ft)		
7.5 m 24.6 ft	kg lb										*2,240 *4,940	*2,240 *4,940	6.49 (21.3)	
6.0 m 19.7 ft	kg lb							*2,360 *5,200	*2,360 *5,200		*2,070 *4,560	*2,070 *4,560	7.58 (24.9)	
4.5 m 14.8 ft	kg lb					*3,850 *8,490	*3,850 *8,490	*3,720 *8,200	2,960 6,530		*2,040 *4,500	*2,040 *4,500	8.25 (27.1)	
3.0 m 9.8 ft	kg lb		*9,630 *21,230	*9,630 *21,230	*5,980 *13,180	*5,980 *13,180	*4,700 *10,360	4,170 9,190	*4,120 *9,080	2,830 6,240	*2,110 *4,650	*2,110 *4,650	8.60 (28.2)	
1.5 m 4.9 ft	kg lb		*6,760 *14,900	*6,760 *14,900	*7,830 *17,260	6,140 13,540	*5,630 *12,410	3,900 8,600	4,570 10,080	2,690 5,930	*2,310 *5,090	2,080 4,590	8.68 (28.5)	
0.0 m 0.0 ft	kg lb		*7,640 *16,840	*7,640 *16,840	*9,080 *20,020	5,830 12,850	6,390 14,090	3,710 8,180	4,460 9,830	2,590 5,710	*2,660 *5,860	2,110 4,650	8.50 (27.9)	
-1.5 m -4.9 ft	kg lb	*6,820 *15,040	*6,820 *15,040	*10,840 *23,900	*10,840 *23,900	*9,550 *21,050	5,740 12,650	6,310 13,910	3,630 8,000	4,430 9,770	2,560 5,640	*3,290 *7,250	2,310 5,090	8.03 (26.3)
-3.0 m -9.8 ft	kg lb	*10,410 *22,950	*10,410 *22,950	*14,010 *30,890	11,930 26,300	*9,290 *20,480	5,820 12,830	6,350 14,000	3,670 8,090		*4,590 *10,120	2,790 6,150	7.21 (23.7)	
-4.5 m -14.8 ft	kg lb		*11,890 *26,210	*11,890 *26,210	*8,090 *17,840	6,050 13,340					*5,730 *12,630	3,970 8,750	5.91 (19.4)	

- Lifting capacity are based on ISO 10567.
- Lifting capacity of the ROBEX series does not exceed 75% of tipping load with the machine on firm, level ground or 87% of full hydraulic capacity.
- The load point is a hook located on the back of the bucket.
- (*) indicates load limited by hydraulic capacity.

 Rating over-front  Rating over-side or 360 degree



HX225S L LONG REACH

8.2 m (26' 11") boom, 6.3 m (20' 8") arm equipped with 800 mm (32") triple grouser shoe, and 5,300 kg (11,690 lb) counterweight.

Load point height m (ft)	Load radius														At max. reach			
	4.5 m (14.8 ft)		6.0 m (19.7 ft)		7.5 m (24.6 ft)		9.0 m (29.5 ft)		10.5 m (34.4 ft)		12.0 m (39.4 ft)		13.5 m (44.3 ft)		Capacity	Reach		
																m (ft)		
10.5 m 34.4 ft	kg lb														*490 *1,080	*490 *1,080	11.06 (36.3)	
9.0 m 29.5 ft	kg lb											*530 *1,170	*530 *1,170		*440 *970	*440 *970	12.10 (39.7)	
7.5 m 24.6 ft	kg lb											*1,050 *2,310	*1,050 *2,310		*420 *930	*420 *930	12.89 (42.3)	
6.0 m 19.7 ft	kg lb									*1,580 *3,480	*1,580 *3,480	*1,370 *3,020	*1,370 *3,020		*420 *930	*420 *930	13.46 (44.2)	
4.5 m 14.8 ft	kg lb									*1,760 *3,880	*1,760 *3,880	*1,650 *3,640	*1,650 *3,640	*780 *1,720	*780 *1,720	*430 *950	*430 *950	13.85 (45.4)
3.0 m 9.8 ft	kg lb							*2,500 *5,510	*2,500 *5,510	*2,190 *4,830	*2,190 *4,830	*1,990 *4,390	*1,990 *4,390	*1,860 *4,100	1,600 3,530	*1,030 *2,270	*1,030 *2,270	14.06 (46.1)
1.5 m 4.9 ft	kg lb	*5,610 *12,370	*5,610 *12,370	*3,920 *8,640	*3,920 *8,640	*3,060 *6,750	*3,060 *6,750	*2,560 *5,640	*2,560 *5,640	*2,240 *4,940	1,970 4,340	*2,030 *4,480	1,500 3,310	*1,180 *2,600	1,140 2,510	*510 *1,120	*510 *1,120	14.11 (46.3)
0.0 m 0.0 ft	kg lb	*6,970 *15,370	6,680 14,730	*4,740 *10,450	4,450 9,810	*3,590 *7,910	3,200 7,050	*2,920 *6,440	2,400 5,290	*2,490 *5,490	1,830 4,030	*2,200 *4,850	1,410 3,110	*1,200 *2,650	1,080 2,380	*580 *1,280	*580 *1,280	14.00 (45.9)
-1.5 m -4.9 ft	kg lb	*5,890 *12,990	*5,890 *12,990	*5,360 *11,820	4,080 8,990	*4,030 *8,880	2,950 6,500	*3,230 *7,120	2,230 4,920	*2,710 *5,970	1,710 3,770	*2,350 *5,180	1,330 2,930	*1,000 *2,200	*1,000 *2,200	*680 *1,500	*680 *1,500	13.72 (45.0)
-3.0 m -9.8 ft	kg lb	*6,050 *13,340	5,940 13,100	*5,750 *12,680	3,880 8,550	*4,350 *9,590	2,790 6,150	*3,470 *7,650	2,110 4,650	*2,880 *6,350	1,630 3,590	*2,360 *5,200	1,280 2,820			*820 *1,810	*820 *1,810	13.26 (43.5)
-4.5 m -14.8 ft	kg lb	*6,820 *15,040	5,900 13,010	*5,920 *13,050	3,790 8,360	*4,520 *9,960	2,710 5,970	*3,610 *7,960	2,040 4,500	2,870 6,330	1,590 3,510	*2,200 *4,850	1,260 2,780			*1,020 *2,250	*1,020 *2,250	12.61 (41.4)
-6.0 m -19.7 ft	kg lb	*8,010 *17,660	5,970 13,160	*5,880 *12,960	3,800 8,380	*4,530 *9,990	2,700 5,950	*3,610 *7,960	2,030 4,480	2,880 6,350	1,590 3,510					*1,340 *2,950	*1,340 *2,950	11.73 (38.5)
-7.5 m -24.6 ft	kg lb	*7,560 *16,670	6,140 13,540	*5,590 *12,320	3,890 8,580	*4,330 *9,550	2,760 6,080	*3,440 *7,580	2,090 4,610	*2,120 *4,670	1,660 3,660					*1,920 *4,230	1,650 3,640	10.56 (34.7)
-9.0 m -29.5 ft	kg lb	*6,630 *14,620	6,430 14,180	*4,960 *10,930	4,080 8,990	*3,820 *8,420	2,910 6,420	*2,900 *6,390	2,240 4,940							*2,910 *6,420	2,240 4,940	9.00 (29.5)
-10.5 m -34.4 ft	kg lb	*5,020 *11,070	*5,020 *11,070	*3,710 *8,180	*3,710 *8,180											*3,150 *6,940	*3,150 *6,940	6.75 (22.1)











- Lifting capacity are based on ISO 10567.
- Lifting capacity of the ROBEX series does not exceed 75% of tipping load with the machine on firm, level ground or 87% of full hydraulic capacity.
- The load point is a hook located on the back of the bucket.
- (*) indicates load limited by hydraulic capacity.

LIFTING CAPACITY













 Rating over-front  Rating over-side or 360 degree

HX225S L HIGH WALKER

5.68 m (18' 8") boom, 2.00 m (6' 7") arm equipped with 600 mm (24") triple grouser shoe, and 3,800 kg (8,380 lb) counterweight.

Load point height m (ft)	Load radius								At max. reach			
	3.0 m (9.8 ft)		4.5 m (14.8 ft)		6.0 m (19.7 ft)		7.5 m (24.6 ft)		Capacity		Reach	
											m (ft)	
7.5m 24.6ft	kg lb								*4,390 *9,680	*4,390 *9,680	5.35 (17.6)	
6.0m 19.7ft	kg lb			*4,370 *9,630	*4,370 *9,630				*4,420 *9,740	*4,420 *9,740	6.58 (21.6)	
4.5m 14.8ft	kg lb	*8,520 *18,780	*8,520 *18,780	*5,780 *12,740	*5,780 *12,740	*4,840 *10,670	*4,840 *10,670		*4,570 *10,080	4,180 9,220	7.30 (24.0)	
3.0m 9.8ft	kg lb			*7,590 *16,730	*7,590 *16,730	*5,630 *12,410	5,540 12,210	*4,830 *10,650	3,890 8,580	*4,790 *10,560	3,760 8,290	7.66 (25.1)
1.5m 4.9ft	kg lb			*9,080 *20,020	8,320 18,340	*6,410 *14,130	5,330 11,750	5,130 11,310	3,790 8,360	4,910 10,820	3,630 8,000	7.71 (25.3)
0.0m 0.0ft	kg lb			*9,690 *21,360	8,190 18,060	*6,900 *15,210	5,220 11,510			5,130 11,310	3,780 8,330	7.46 (24.5)
-1.5m -4.9ft	kg lb	*13,920 *30,690	*13,920 *30,690	*9,560 *21,080	8,240 18,170	*6,930 *15,280	5,230 11,530			5,830 12,850	4,290 9,460	6.87 (22.6)
-3.0m -9.8ft	kg lb	*12,250 *27,010	*12,250 *27,010	*8,630 *19,030	8,440 18,610					*6,380 *14,070	5,610 12,370	5.84 (19.2)
-4.5m -14.8ft	kg lb									*6,800 *14,990	*6,800 *14,990	4.04

5.68 m (18' 8") boom, 2.40 m (7' 10") arm equipped with 600 mm (24") triple grouser shoe, and 3,800 kg (8,380 lb) counterweight.













Load point height m (ft)	Load radius										At max. reach		
	1.5 m (4.9 ft)		3.0 m (9.8 ft)		4.5 m (14.8 ft)		6.0 m (19.7 ft)		7.5 m (24.6 ft)		Capacity		Reach
													m (ft)
7.5 m 24.6 ft	kg lb										*3,490 *7,690	*3,490 *7,690	5.97 (19.6)
6.0 m 19.7 ft	kg lb					*3,940 *8,690	*3,940 *8,690				*3,280 *7,230	*3,280 *7,230	7.09 (23.3)
4.5 m 14.8 ft	kg lb			*5,200 *11,460	*5,200 *11,460	*4,460 *9,830	*4,460 *9,830	*4,200 *9,260	4,000 8,820	*3,290 *7,250	*3,290 *7,250	7.77 (25.5)	
3.0 m 9.8 ft	kg lb			*7,020 *15,480	*7,020 *15,480	*5,290 *11,660	*5,290 *11,660	*4,550 *10,030	3,880 8,550	*3,460 *7,630	3,400 7,500	8.11 (26.6)	
1.5 m 4.9 ft	kg lb			*8,660 *19,090	8,350 18,410	*6,140 *13,540	5,320 11,730	*4,970 *10,960	3,760 8,290	*3,840 *8,470	3,300 7,280	8.15 (26.8)	
0.0 m 0.0 ft	kg lb			*7,490 *16,510	*7,490 *16,510	*9,520 *20,990	8,150 17,970	*6,740 *14,860	5,180 11,420	5,030 11,090	3,690 8,140	*4,520 *9,960	7.92 (26.0)
-1.5 m -4.9 ft	kg lb	*8,420 *18,560	*8,420 *18,560	*12,580 *27,730	*12,580 *27,730	*9,610 *21,190	8,150 17,970	*6,920 *15,260	5,160 11,380		5,190 11,440	3,810 8,400	7.37 (24.2)
-3.0 m -9.8 ft	kg lb	*13,210 *29,120	*13,210 *29,120	*13,030 *28,730	*13,030 *28,730	*8,940 *19,710	8,310 18,320	*6,440 *14,200	5,270 11,620		*5,850 *12,900	4,780 10,540	6.42 (21.1)
-4.5 m -14.8 ft	kg lb			*10,120 *22,310	*10,120 *22,310	*6,960 *15,340	*6,960 *15,340				*6,330 *13,960	*6,330 *13,960	4.84 (15.9)

- Lifting capacity are based on ISO 10567.
- Lifting capacity of the ROBEX series does not exceed 75% of tipping load with the machine on firm, level ground or 87% of full hydraulic capacity.
- The load point is a hook located on the back of the bucket.
- (*) indicates load limited by hydraulic capacity.















 Rating over-front  Rating over-side or 360 degree

HX225S L HIGH WALKER

5.68 m (18' 8") boom, 2.92 m (9' 7") arm equipped with 600 mm (24") triple grouser shoe, and 3,800 kg (8,380 lb) counterweight.

Load point height m (ft)	Load radius										At max. reach					
	1.5 m (4.9 ft)		3.0 m (9.8 ft)		4.5 m (14.8 ft)		6.0 m (19.7 ft)		7.5 m (24.6 ft)		Capacity		Reach			
													m (ft)			
7.5 m 24.6 ft	kg lb												*2,210 *4,870	*2,210 *4,870	6.67 (21.9)	
6.0 m 19.7 ft	kg lb									*2,730 *6,020	*2,730 *6,020		*2,060 *4,540	*2,060 *4,540	7.69 (25.2)	
4.5 m 14.8 ft	kg lb									*3,950 *8,710	*3,950 *8,710	*3,760 *8,290	*3,760 *8,290	*2,040 *4,500	*2,040 *4,500	8.31 (27.3)
3.0 m 9.8 ft	kg lb			*10,360 *22,840	*10,360 *22,840	*6,240 *13,760	*6,240 *13,760	*4,820 *10,630	*4,820 *10,630	*4,180 *9,220	3,860 8,510	*2,130 *4,700	*2,130 *4,700	8.63 (28.3)		
1.5 m 4.9 ft	kg lb			*6,570 *14,480	*6,570 *14,480	*8,050 *17,750	*8,050 *17,750	*5,750 *12,680	5,320 11,730	*4,670 *10,300	3,720 8,200	*2,340 *5,160	*2,340 *5,160	8.67 (28.5)		
0.0 m 0.0 ft	kg lb			*7,990 *17,610	*7,990 *17,610	*9,190 *20,260	8,110 17,880	*6,480 *14,290	5,140 11,330	4,960 10,930	3,630 8,000	*2,720 *6,000	*2,720 *6,000	8.45 (27.7)		
-1.5 m -4.9 ft	kg lb	*7,280 *16,050	*7,280 *16,050	*11,360 *25,040	*11,360 *25,040	*9,560 *21,080	8,040 17,730	*6,820 *15,040	5,070 11,180	4,940 10,890	3,610 7,960	*3,410 *7,520	*3,410 *7,520	7.94 (26.0)		
-3.0 m -9.8 ft	kg lb	*10,930 *24,100	*10,930 *24,100	*13,810 *30,450	*13,810 *30,450	*9,200 *20,280	8,140 17,950	*6,620 *14,590	5,130 11,310			*4,870 *10,740	*4,870 *10,740	7.07 (23.2)		
-4.5 m -14.8 ft	kg lb			*11,470 *25,290	*11,470 *25,290	*7,820 *17,240	*7,820 *17,240					*5,800 *12,790	*5,800 *12,790	5.68 (18.6)		

5.68 m (18' 8") boom, 3.90 m (12' 9") arm equipped with 600 mm (24") triple grouser shoe, and 3,800 kg (8,380 lb) counterweight.

Load point height m (ft)	Load radius										At max. reach							
	1.5 m (4.9 ft)		3.0 m (9.8 ft)		4.5 m (14.8 ft)		6.0 m (19.7 ft)		7.5 m (24.6 ft)		9.0 m (29.5 aft)		Capacity		Reach			
															m (ft)			
7.5 m 24.6 ft	kg lb													*2,190 *4,830	*2,190 *4,830	7.87 (25.8)		
6.0 m 19.7 ft	kg lb									*2,690 *5,930	*2,690 *5,930			*1,310 *2,890	*1,310 *2,890	8.75 (28.7)		
4.5 m 14.8 ft	kg lb									*2,980 *6,570	*2,980 *6,570	*2,100 *4,630	*2,100 *4,630	*1,290 *2,840	*1,290 *2,840	9.30 (30.5)		
3.0 m 9.8 ft	kg lb									*3,880 *8,550	*3,880 *8,550	*3,470 *7,650	*3,470 *7,650	*2,890 *6,370	2,760 6,080	*1,330 *2,930	*1,330 *2,930	9.59 (31.4)
1.5 m 4.9 ft	kg lb			*11,520 *25,400	*11,520 *25,400	*6,710 *14,790	*6,710 *14,790	*4,910 *10,820	*4,910 *10,820	*4,050 *8,930	3,670 8,090	*3,370 *7,430	2,670 5,890	*1,440 *3,170	*1,440 *3,170	9.63 (31.6)		
0.0 m 0.0 ft	kg lb	*3,400 *7,500	*3,400 *7,500	*8,640 *19,050	*8,640 *19,050	*8,280 *18,250	8,050 17,750	*5,830 *12,850	5,060 11,160	*4,590 *10,120	3,530 7,780	*3,320 *7,320	2,600 5,730	*1,640 *3,620	*1,640 *3,620	9.43 (30.9)		
-1.5 m -4.9 ft	kg lb	*5,750 *12,680	*5,750 *12,680	*10,050 *22,160	*10,050 *22,160	*9,140 *20,150	7,830 17,260	*6,440 *14,200	4,910 10,820	4,780 10,540	3,440 7,580			*1,990 *4,390	*1,990 *4,390	8.97 (29.4)		
-3.0 m -9.8 ft	kg lb	*8,400 *18,520	*8,400 *18,520	*13,060 *28,790	*13,060 *28,790	*9,280 *20,460	7,830 17,260	*6,620 *14,590	4,890 10,780	4,790 10,560	3,450 7,610			*2,630 *5,800	*2,630 *5,800	8.21 (27.0)		
-4.5 m -14.8 ft	kg lb	*11,620 *25,620	*11,620 *25,620	*13,120 *28,920	*13,120 *28,920	*8,640 *19,050	7,990 17,610	*6,160 *13,580	5,010 11,050					*4,070 *8,970	3,920 8,640	7.06 (23.2)		
-6.0 m (-20 ft)	kg lb			*10,050 *22,160	*10,050 *22,160	*6,640 *14,640	*6,640 *14,640							*5,340 *11,770	*5,340 *11,770	5.25 (17.2)		

- Lifting capacity are based on ISO 10567.
- Lifting capacity of the ROBEX series does not exceed 75% of tipping load with the machine on firm, level ground or 87% of full hydraulic capacity.
- The load point is a hook located on the back of the bucket.
- (*) indicates load limited by hydraulic capacity.