

Robex

25z-9AK

With Tier 4 Final Engine installed

MOVING YOU FURTHER

HYUNDAI CONSTRUCTION EQUIPMENT



*Photo may include optional equipment.

 **HYUNDAI**
CONSTRUCTION EQUIPMENT

PRIDE AT WORK

Hyundai Heavy Industries strives to build state-of-the-art earthmoving equipment to give every operator maximum performance, more precision, versatile machine preferences, and proven quality.

Moving you further !



Robex 25Z-9AK

Machine Walk-Around



*Photo may include optional equipment.

Engine Technology

Proven, reliable, fuel efficient, low emission and low noise Kubota Tier 4 final.

Rugged Upper and Lower Frame

The upper frame is designed to be heavy duty to absorb high stress load on the job. X-leg center frame and reinforced box section track frame provide exceptional strength and longer service life to withstand tough working conditions.

Efficient Control System

Control devices are all conveniently located for improved operator comfort and productivity. A safety lever on the left-side console is designed to prevent exiting the cabin while hydraulic controls are live.

Advanced Hydraulic System

The R25Z-9AK hydraulic system is precision designed for fast operation with fine control capabilities.

Comfortable and Durable Cabin

The cabin is roomy and ergonomically designed, with reduced sound levels and good visibility. Both canopy and cabin style frames meet international standards TOPS, FOPS ensuring operator's safety.

Operator Convenience

The R25Z-9AK features a suspension seat, foldable pedals for added space and multiple storage compartments.

The monitoring system includes seven warning indicators, water temperature gauge, fuel gauge and hour meter for productive, convenient operating.

Easy and Simple Maintenance

An adjustable suspension seat, wrist rests, ergonomically designed joysticks and plenty of leg room help to reduce operator fatigue. A array of indicators and gauges are displayed on the monitor which keep the operator aware of machine performance at all times. The monitoring system includes seven warning indicators, water temperature gauge, fuel gauge and hour meter.

Extended Life of Components

The R25Z-9AK reduces operating costs over time with long life hydraulic filters, hydraulic oil, shims and bushings.

PRECISION

Innovative hydraulic system technologies make the 9A series excavator fast, smooth and easy to control.



*Photo may include optional equipment.

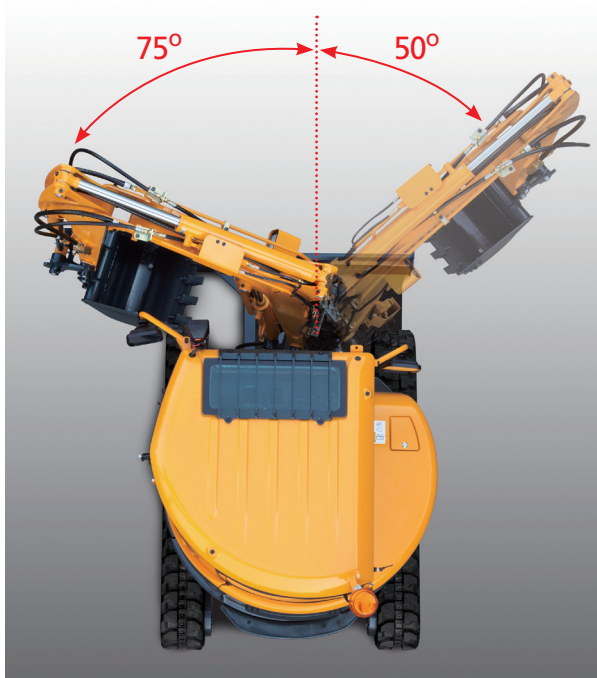

Boom Swing

The R25Z-9AK's boom swing function is designed for efficient work in congested residential and urban areas. The boom can be offset left or right within an operating range.



Easy to transport

The new R25Z-9AK can be moved on a small trailer, with a simple car driver's licence. No truck is required to easily transport the machine to a jobsite, and back to the yard.

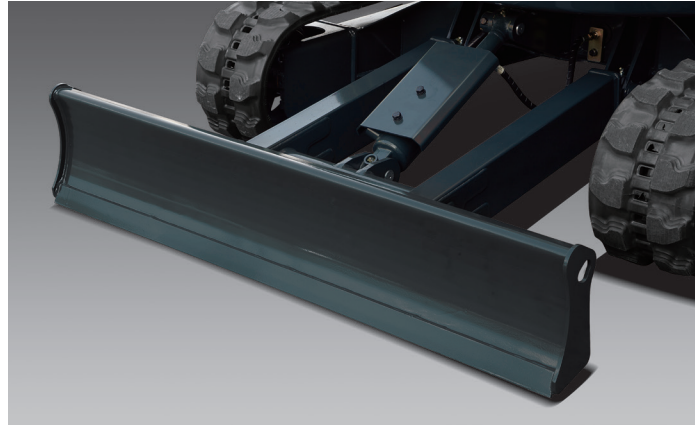

Dozer Blade

Large dozer blade provides added versatility, work efficiency and stability for the job.

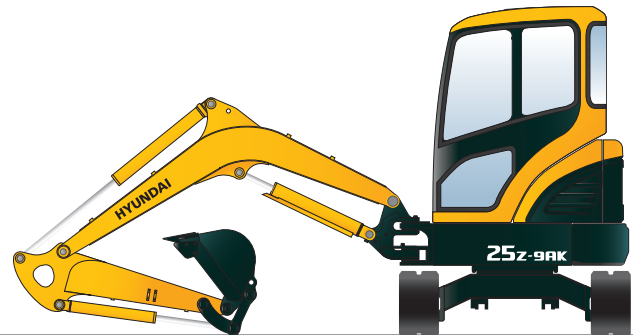

Zero-tail Swing

R25Z-9AK's short tail swing radius allows the operator work in confined areas like close to buildings on roadways, and in urban areas. This compact radius design provides easy and efficient operation in any limited space work environment.

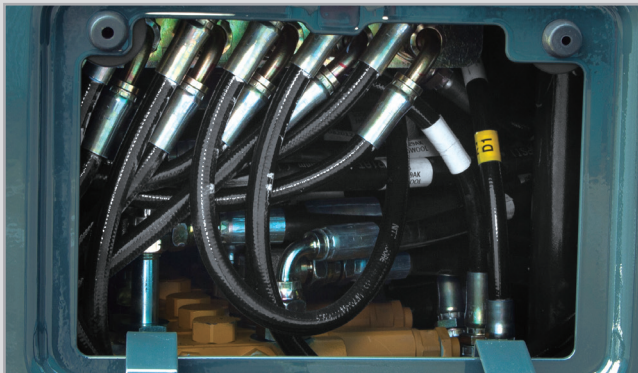

Lever Pattern Change Valve

Joystick control patterns can be changed through an optional pattern change valve positioned for easy access.

PERFORMANCE

9A series is designed for maximum performance to keep the operator working productively.



*Photo may include optional equipment.



Cylinder Covers

Standard boom and dozer cylinder covers provide added protection.



Structure Strength

The R25Z-9AK cabin structure has been fitted with stronger but slimmer tubing for added safety and improved visibility. Low-stress, high strength steel is integrally welded to form a stronger, more durable upper and lower frame. Structural integrity was tested by way of FEM (Finite Elements Method) analysis and long-term durability tests.

Kubota D1305

Emissions: The most compact multi-cylinder liquid cooled industrial diesel engines comply with EPA Tier 4 Emission regulations without additional After Treatment Tools. This engine meets standards over the NRTC and NTE requirements.

Lower Noise Level: The half-float valve cover and MoS₂ coated piston reduce noise levels and vibration.

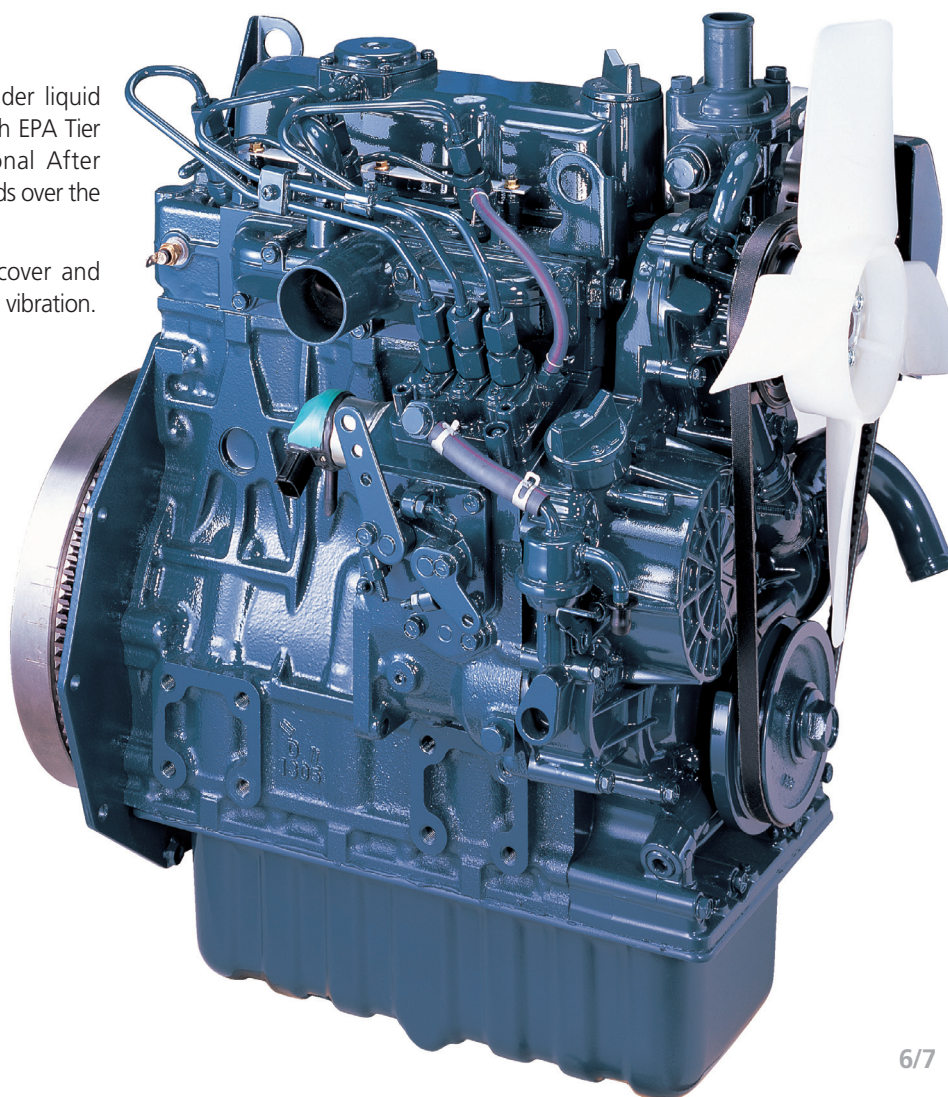

PREFERENCE

Operating a 9A series is unique to every operator. Operators can fully customize their work environment and operating preferences to fit their individual needs.



*Photo may include optional equipment.



Monitor

The monitoring system of the R25Z-9AK provides the operator with machine status information, including: engine oil pressure lamp, battery charge lamp, engine coolant temperature and a fuel gauge.

Comfortable Operating Cabin

In a 9A series cabin, you can easily adjust the seat and wrist rests settings to best suit your preferred operating condition.

1. All pedals are foldable for additional floor space. Foot rest, attachment pedal, left and right travel pedals and boom swing pedal are arranged for convenient access.
2. Two cup holders are integrated into the right console for large and small drink storage.
3. An additional storage box with key lock is accessible under the operator's seat.
4. Adjustable wrist rests provide additional comfort.
5. A sliding fold-in front window is easily opened and safely stored in an open position to improve ventilation and visibility.(Cabin type only)

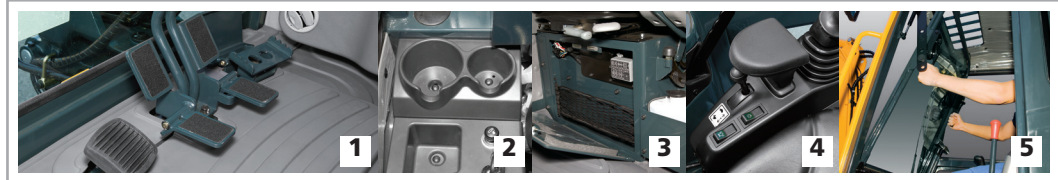

Reduced Stress

An operator's work environment should be stress free. Hyundai's R25Z-9AK compact excavator is designed for comfort, reduced sound and plenty of space to reduce stress on the operator.

Operator Comfort

The left and right control levers are ergonomically located for convenient access. A safety lock system is designed to prevent exiting the cabin while hydraulic controls are live. When the safety lever and left side console are positioned upright, hydraulic functions are disengaged.



A tiltable left-side console make the operator easier to enter and exit the cab.



PROFITABILITY

9A series is designed to maximize profitability through improved efficiencies, enhanced service features and longer life components.

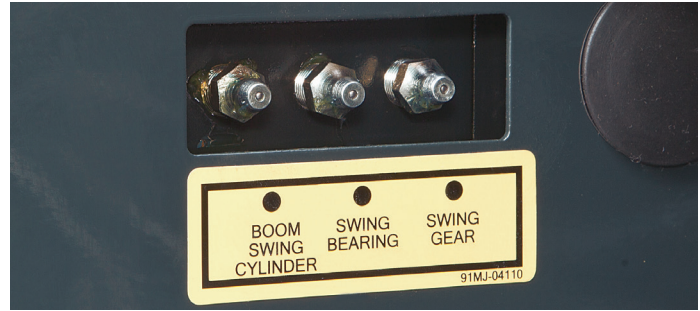

*Photo may include optional equipment.



Easy Change Air Cleaner

The R25Z-9AKK is equipped with a durable plastic air cleaner designed for easy maintenance.



Centralized Grease Fittings

A centralized lubrication bank is available for faster, easier service and maintenance.



Selector Valve for Single or Double Acting Piping

Double Acting Pipe located on front of the Fuel Tank for easy to access and control.

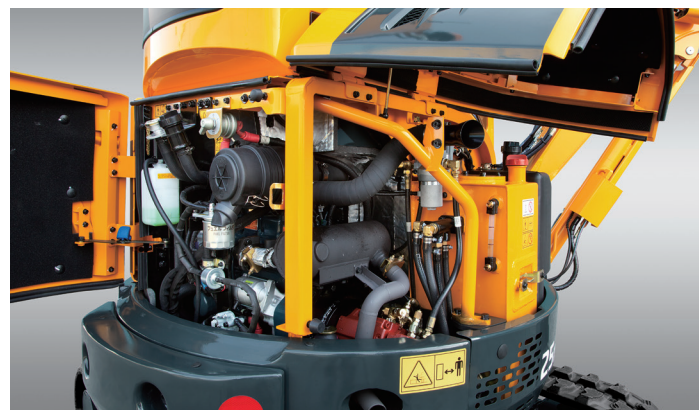
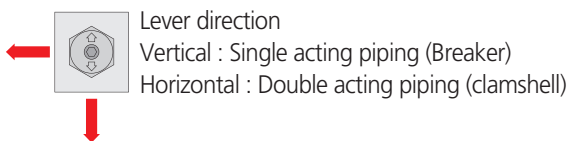

Easy Access

The R25Z-9AK was built with accessibility in mind. All doors, covers and hoods were built for complete open access. Regular service and maintenance is easy and convenient with the R25Z-9AK.



Proportional Auxiliary Hydraulic System

- Opt: Proportional Control Switch for better speed control
- Enlarge the Operation Convenience



Long-Life Components

9A series excavators were designed with bushings designed for long-life lube intervals (250 hrs) & polymer shims (wear resistant, noise reducing), long-life hydraulic filters (1,000hrs), long-life hydraulic oil (5,000hrs), more efficient cooling systems and integrated preheating systems which extend service intervals, minimize operating costs and reduce machine down time.

Specifications

ENGINE

Model	Kubota D1305		
Type	4 Cycle. In line, water cooled Diesel		
Rated flywheel horse power			
SAE	J1995 (gross)	24.9 HP (18.5kW) at 2,400rpm	
	J1349 (net)	24.4 HP (18.2kW) at 2,400rpm	
DIN	627 1/1 (gross)	25.2 PS (18.5kW) at 2,400rpm	
	627 1/1 (net)	23.5 PS (18.2kW) at 2,400rpm	
Max. torque	8.3 kgf.m(60.17 lbf.ft) at 1,600 rpm		
Bore x stroke	78mm x 88mm (3.07" x 3.46")		
Piston displacement	1,261cc (76.9 in ³)		
Batteries	12V - 80AH		
Starting motor	12V - 1.4kW		
Alternator	12V - 40A		

HYDRAULIC SYSTEM

Main pumps	
Type	variable displacement piston pumps
Rated flow	2 x 27.6 + 19.6 L/min
Sub-pump for pilot circuit	Gear pump
Hydraulic motors	
Travel	Two speed axial piston motor with counter balance valve and parking brake
Swing	Axial piston motor with automatic brake
Relief valve setting	
Implement circuits	220 Kg/cm ² (3,130 psi)
Travel circuit	220 Kg/cm ² (3,130 psi)
Swing circuit	175 Kg/cm ² (2,489 psi)
Pilot circuit	30 Kg/cm ² (430 psi)
Service valve	Installed

HYDRAULIC CYLINDER

No. of cylinder - bore x stroke	
Boom	75 x 562 mm (3.0" x 22.2")
Arm	70 x 500 mm (2.8" x 19.7")
Bucket	55 X 420 mm (2.16" x 16.5")
Boom swing	75 X 400 mm (3.0" x 15.7")
Dozer blade	85 X 140 mm (3.3" x 5.5")

* Hyundai Bio Hydraulic Oil (HBHO) available

NOISE LEVEL(CAB)

Noise Levels (dynamic value)	
LwA	94dB
LpA	75dB

COOLANT & LUBRICANT CAPACITY

(refilling)	liter	US gal	UK gal
Fuel tank	30	7.9	6.6
Engine coolant	5.0	1.3	1.1
Engine oil	5.9	1.6	1.3
Hydraulic tank	27	7.1	5.9

TRAVEL LEVERS

Traveling and steering : Two levers with pedals.

CONTROL LEVERS

Type	
Pilot control	Two joysticks with one safety lever (LH): Swing and arm, (RH): Boom and bucket with horn (ISO)
Engine throttle	Mechanical, cable type

SWING SYSTEM

Swing motor	Axial piston motor
Swing reduction	Planetary gear reduction
Swing circuit lubrication	Grease - bathed
Swing brake	Wet disc
Swing speed	9.1 rpm

DRIVES & BRAKES

Max. travel speed(high) / (low)	4.3km / 2.4km (2.7mph) / (1.5mph)
Maximum traction force	2.4ton
Maximum gradeability	30°
Parking brake	Wet disc

DIGGING FORCE(ISO)

Bucket	2,150 kgf
	21.1 kN
	4,740 lbf
Arm [Long Arm]	1,490 [1,310] kgf
	14.6 [12.8] kN
	3,280 [2,890] lbf

WEIGHT(APPROXIMATE)

Operating weight, including 1,945 mm (6' 5") boom, 1,120 mm (3' 8") arm, SAE heaped 0.07 m³ (0.1 yd³) excavator bucket, lubricant, coolant, full fuel tank, hydraulic tank and the standard equipment.

Shoe Width	Rubber shoe 250 mm (10")	
Operating Weight	Cabin	2,580 Kg (5,690lb)
	Canopy	2,430 Kg (5,360lb)
Ground Pressure	Cabin	0.32 kg / cm ² (4.6psi)
	Canopy	0.30 kg / cm ² (4.34psi)

UNDERCARRIAGE

X-leg type center frame is integrally welded with reinforced box-section track frames. The undercarriage includes lubricated rollers, track adjusters with shock absorbing springs and sprockets, and rubber shoes.

Center frame	X-leg type
Track frame	Pentagonal box type
No. of carrier roller on each side	1
No. of track roller on each side	3

Dimensions & Working Range

R25Z-9AK DIMENSIONS

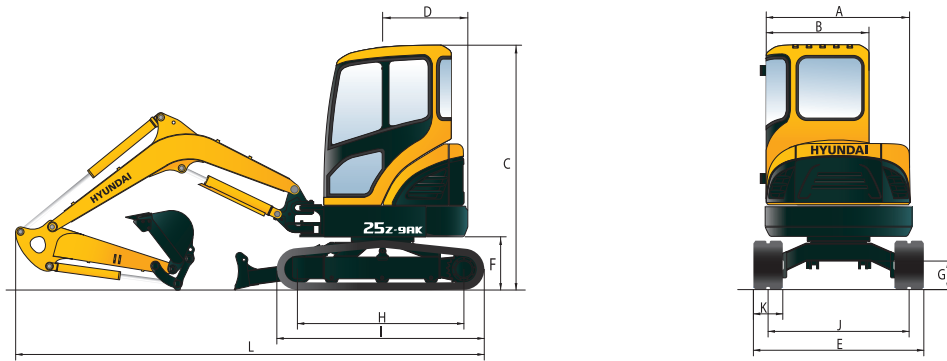

mm (ft-in)

A	Overall width of upper structure	1,485 (4' 10")	G	Ground clearance	290 (11")
B	Overall width of cab	1,050 (3' 5")	H	Tumbler distance	1,490 (4' 11")
C	Overall height of cab	2,500 (8' 2")	I	Track length	1,910 (6' 3")
D	Tail swing radius	775 (2' 7")	J	Track gauge	1,250 (4' 1")
	With additional counterweight	875 (2' 10")	K	Track shoe width	250 (10")
E	Overall width	1,500 (4' 11")	L	Overall length	4,030 (13' 3")
F	Clearance under counterweight	510 (1' 8")		Long Arm	4,100 (13' 5")

R25Z-9AK WORKING RANGE

mm (ft-in)

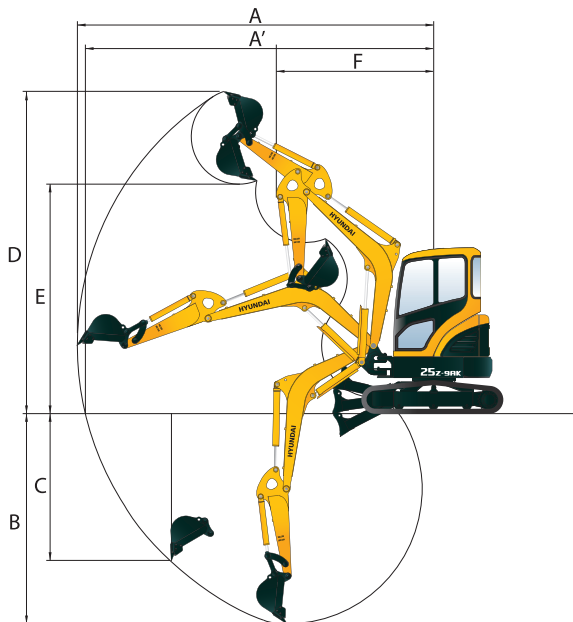

	Boom length	1,945 (6' 5")
	Arm length	1,120 (3' 8") *1,350 (4' 5")
A	Max. digging reach	4,480 (14' 8") *4,680 (15' 4")
A'	Max. digging reach at ground	4,340 (14' 3") *4,540 (14' 11")
B	Max. digging depth	2,420 (7' 11") *2,645 (8' 8")
C	Max. vertical wall digging depth	1,460 (4' 9") *1,605 (5' 3")
D	Max. digging height	4,090 (13' 5") *4,180 (13' 9")
E	Max. dumping height	2,885 (9' 6") *2,970 (9' 9")
F	Min. swing radius	2,000 (6' 7") *1,990 (6' 6")











* Long Arm

Lifting capacity











R25Z-9AK

 Rating over-front  Rating over-side or 360 degree

Boom : 1.945 m (6' 5") / Arm : 1.12 m (3' 8") / Bucket : 0.07 m³ SAE heaped / Dozer Down : 250mm(9.8") Rubber track Cabin Type W/O ADD CWT

Load point height m(ft)		Load radius								At max. reach		
		2.0 m(5 ft)		2.5 m(10 ft)		3.0 m(10 ft)		3.5 m(10 ft)		Capacity		Reach m (ft)
												
3.5 m	kg									*560	450	3.07
10 ft	lb									*1,230	990	(10.1)
3.0 m	kg					*590	460			*570	340	3.59
10 ft	lb					*1,300	1,010			*1,260	750	(11.8)
2.5 m	kg					*590	460	*600	350	*590	290	3.92
10 ft	lb					*1,300	1,010	*1,320	770	*1,300	640	(12.9)
2.0 m	kg			*670	610	*650	450	*650	350	*600	260	4.13
5 ft	lb			*1,480	1,340	*1,430	990	*1,430	770	*1,320	570	(13.5)
1.5 m	kg	*1,180	860	*890	590	*770	440	*700	340	*620	240	4.24
5 ft	lb	*2,600	1,900	*1,960	1,300	*1,700	970	*1,540	750	*1,370	530	(13.9)
1.0 m	kg	*1,760	800	*1,150	560	*900	420	*770	330	*640	240	4.26
5 ft	lb	*3,880	1,760	*2,540	1,230	*1,980	930	*1,700	730	*1,410	530	(14.0)
0.5 m	kg	*1,750	770	*1,340	540	*1,010	410	*830	320	*660	240	4.19
0 ft	lb	*3,860	1,700	*2,950	1,190	*2,230	900	*1,830	710	*1,460	530	(13.7)
Ground	kg	*1,990	760	*1,430	530	*1,070	400	*850	320	*680	260	4.04
Line	lb	*4,390	1,680	*3,150	1,170	*2,360	880	*1,870	710	*1,500	570	(13.3)
-0.5 m	kg	*2,030	760	*1,420	530	*1,060	400	*820	320	*690	290	3.78
-0 ft	lb	*4,480	1,680	*3,130	1,170	*2,340	880	*1,810	710	*1,520	640	(12.4)
-1.0 m	kg	*1,810	770	*1,290	530	*960	400			*690	350	3.36
-5 ft	lb	*3,990	1,700	*2,840	1,170	*2,120	880			*1,520	770	(11.0)
-1.5 m	kg	*1,410	780	*990	540					*610	500	2.67
-5 ft	lb	*3,110	1,720	*2,180	1,190					*1,340	1,100	(8.8)
-2.5 m	kg									*480	370	3.38
-10 ft	lb									*1,060	820	(11.1)

Boom : 1.945 m (6' 5") / Arm : 1.12 m (3' 8") / Bucket : 0.07 m³ SAE heaped / Dozer up : 250mm(9.8") rubber track . Cabin Type . W/O ADD CWT













Load point height m(ft)		Load radius								At max. reach		
		2.0 m(5 ft)		2.5 m(10 ft)		3.0 m(10 ft)		3.5 m(10 ft)		Capacity		Reach m (ft)
												
3.5 m	kg									440	440	3.07
10 ft	lb									970	970	(10.1)
3.0 m	kg					450	450			330	330	3.59
10 ft	lb					990	990			730	730	(11.8)
2.5 m	kg					450	450	340	340	280	280	3.92
10 ft	lb					990	990	750	750	620	620	(12.9)
2.0 m	kg			610	600	450	440	340	340	250	250	4.13
5 ft	lb			1,340	1,320	990	970	750	750	550	550	(13.5)
1.5 m	kg	870	840	590	580	430	430	330	330	240	240	4.24
5 ft	lb	1,920	1,850	1,300	1,280	950	950	730	730	530	530	(13.9)
1.0 m	kg	810	780	560	550	420	410	320	320	230	230	4.26
5 ft	lb	1,790	1,720	1,230	1,210	930	900	710	710	510	510	(14.0)
0.5 m	kg	780	750	540	530	400	400	320	320	240	240	4.19
0 ft	lb	1,720	1,650	1,190	1,170	880	880	710	710	530	530	(13.7)
Ground	kg	770	740	530	520	400	390	310	310	250	250	4.04
Line	lb	1,700	1,630	1,170	1,150	880	860	680	680	550	550	(13.3)
-0.5 m	kg	770	740	530	520	390	390	310	310	280	280	3.78
-0 ft	lb	1,700	1,630	1,170	1,150	860	860	680	680	620	620	(12.4)
-1.0 m	kg	770	750	530	520	400	390			340	340	3.36
-5 ft	lb	1,700	1,650	1,170	1,150	880	860			750	750	(11.0)
-1.5 m	kg	790	760	540	530					500	490	2.67
-5 ft	lb	1,740	1,680	1,190	1,170					1,100	1,080	(8.8)
-2.5 m	kg									360	360	3.38
-10 ft	lb									790	790	(11.1)

- Lifting capacity is based on SAE J1097, ISO 10567.
- Lifting capacity of the Robex Series does not exceed 75% of the tipping load with the machine on firm, level ground or 87% of full hydraulic capacity.
- The load point is a hook located (standard equipment) on the back of the bucket.
- (*) indicates the load limited by hydraulic capacity.













Lifting capacity

 Rating over-front  Rating over-side or 360 degree

Boom : 1.945 m (6' 5") / Arm : 1.35 m (4' 5") / Bucket : 0.07 m³ SAE heaped / Dozer Down : 250mm(9.8") rubber track. Cabin Type. W/O ADD CWT

Load point height m(ft)		Load radius										At max. reach		
		2.0 m(5 ft)		2.5 m(10 ft)		3.0 m(10 ft)		3.5 m(10 ft)		4.0 m(15 ft)		Capacity		Reach m (ft)
														
3.5 m	kg											*500	380	3.39
10 ft	lb											*1,100	840	(11.1)
3.0 m	kg											*510	300	3.85
10 ft	lb											*1,120	660	(12.6)
2.5 m	kg							*540	350			*530	260	4.15
10 ft	lb							*1,190	770			*1,170	570	(13.6)
2.0 m	kg					*550	450	*570	350			*550	240	4.34
5 ft	lb					*1,210	990	*1,260	770			*1,210	530	(14.2)
1.5 m	kg			*740	600	*670	440	*630	340	*610	270	*570	220	4.44
5 ft	lb			*1,630	1,320	*1,480	970	*1,390	750	*1,340	600	*1,260	490	(14.6)
1.0 m	kg	*1,480	820	*1,010	570	*820	430	*710	330	*650	260	*590	220	4.46
5 ft	lb	*3,260	1,810	*2,230	1,260	*1,810	950	*1,570	730	1,430	570	*1,300	490	(14.6)
0.5 m	kg	*1,930	780	*1,250	550	*950	410	*790	320	*680	260	*610	220	4.40
0 ft	lb	*4,250	1,720	*2,760	1,210	*2,090	900	*1,740	710	*1,500	570	*1,340	490	(14.4)
Ground	kg	*2,020	760	*1,390	530	*1,040	400	*840	310			*630	230	4.25
Line	lb	*4,450	1,680	*3,060	1,170	*2,290	880	*1,850	680			*1,390	510	(13.9)
-0.5 m	kg	*2,090	750	*1,430	520	*1,070	390	*840	310			*660	250	4.01
-0 ft	lb	*4,610	1,650	*3,150	1,150	*2,360	860	*1,850	680			*1,460	550	(13.2)
-1.0 m	kg	*1,950	750	*1,360	520	*1,020	390					*670	300	3.64
-5 ft	lb	*4,300	1,650	*3,000	1,150	*2,250	860					*1,480	660	(11.9)
-1.5 m	kg	*1,650	760	*1,160	530							*660	400	3.06
-5 ft	lb	*3,640	1,680	*2,560	1,170							*1,460	880	(10.0)
-2.0 m	kg	*1,040	790											
-5 ft	lb	*2,290	1,740											
-2.5 m	kg											*510	420	(3.07)
-10 ft	lb											*1,120	930	(10.1)

Boom : 1.945 m (6' 5") / Arm : 1.35 m (4' 5") / Bucket : 0.07 m³ SAE heaped / Dozer Down : 250mm(9.8") rubber track. Cabin Type. W/O ADD CWT

Load point height m(ft)		Load radius										At max. reach		
		2.0 m(5 ft)		2.5 m(10 ft)		3.0 m(10 ft)		3.5 m(10 ft)		4.0 m(15 ft)		Capacity		Reach m (ft)
														
3.5 m	kg											370	370	3.39
10 ft	lb											820	820	(11.1)
3.0 m	kg											290	290	3.85
10 ft	lb											640	640	(12.6)
2.5 m	kg							340	340			250	250	4.15
10 ft	lb							750	750			550	550	(13.6)
2.0 m	kg					450	440	340	340			230	230	4.34
5 ft	lb					990	970	750	750			510	510	(14.2)
1.5 m	kg			600	590	440	430	330	330	260	260	220	220	4.44
5 ft	lb			1,320	1,300	970	950	730	730	570	570	490	490	(14.6)
1.0 m	kg	830	800	570	560	420	420	320	320	260	260	210	210	4.46
5 ft	lb	1,830	1,760	1,260	1,230	930	930	710	710	570	570	460	460	(14.6)
0.5 m	kg	790	760	540	530	410	400	310	310	250	250	210	220	4.40
0 ft	lb	1,740	1,680	1,190	1,170	900	880	680	680	550	550	460	490	(14.4)
Ground	kg	770	740	530	520	390	390	310	310			220	230	4.25
Line	lb	1,700	1,630	1,170	1,150	860	860	680	680			490	510	(13.9)
-0.5 m	kg	760	730	520	510	390	380	300	300			250	250	4.01
-0 ft	lb	1,680	1,610	1,150	1,120	860	840	660	660			550	550	(13.2)
-1.0 m	kg	760	730	520	510	390	380					290	290	3.64
-5 ft	lb	1,680	1,610	1,150	1,120	860	840					640	640	(11.9)
-1.5 m	kg	770	740	530	520							390	390	3.06
-5 ft	lb	1,700	1,630	1,170	1,150							860	860	(10.0)
-2.0 m	kg	790	760											
-5 ft	lb	1,740	1,680											
-2.5 m	kg											410	410	(3.07)
-10 ft	lb											900	900	(10.1)

- Lifting capacity is based on SAE J1097, ISO 10567.
- Lifting capacity of the Robex Series does not exceed 75% of the tipping load with the machine on firm, level ground or 87% of full hydraulic capacity.
- The load point is a hook located (standard equipment) on the back of the bucket.
- (*) indicates the load limited by hydraulic capacity.

STANDARD EQUIPMENT

<ul style="list-style-type: none"> ISO standard canopy -Canopy TOPS(ISO 12117) -Safety glass windows -Sliding fold-in front window -Sliding side window -Lockable door -Accessory box -Centralized monitoring 	<ul style="list-style-type: none"> -Gauges <ul style="list-style-type: none"> Fuel level gauge Engine coolant temperature gauge -Warning <ul style="list-style-type: none"> Engine oil pressure Engine coolant temperature Preheat Low battery 	<ul style="list-style-type: none"> Air cleaner closing Fuel empty -Door and locks, one key -Radio / USB player -Mechanical suspension seat with seat belt -Console box tilting system(LH.) -Two front working lights -Electric horn 	<ul style="list-style-type: none"> -Battery (1 x 12 V x 80 AH) -Battery master switch -Automatic swing brake -Removable reservoir tank -Water separator, fuel line -Mono boom (1.945 m, 6' 5") -Arm (1.12 m, 3' 8") -Rubber crawler (250mm, 10") -Single acting piping (Breaker, etc) 	<ul style="list-style-type: none"> -Double acting piping (Clamshell, etc)
---------------------------------------------------------------------------------------------------------------------------------------------------------------------------------------------------------------------------------------------------------------------------------------------	------------------------------------------------------------------------------------------------------------------------------------------------------------------------------------------------------------------------------------------------------------------------------------------------------------------------------------------------------------------------	-------------------------------------------------------------------------------------------------------------------------------------------------------------------------------------------------------------------------------------------------------------------------------------------------------------------	------------------------------------------------------------------------------------------------------------------------------------------------------------------------------------------------------------------------------------------------------------------------------------------------------------------------------------------------------------------------------	------------------------------------------------------------------------------------------

OPTIONAL EQUIPMENT

<ul style="list-style-type: none"> ISO standard cabin -Cabin FOPS(ISO 10262 Level I) TOPS(ISO 12117) -All-weather steel cab with all-around visibility 	<ul style="list-style-type: none"> -Beacon lamp -Accumulator, work equipment lowering -Travel alarm -Quick coupler 	<ul style="list-style-type: none"> -Tool kit -Long Arm (1.35m, 4'5") -Heater & Defroster -Lever pattern change valve -Additional CWT 	<ul style="list-style-type: none"> -Proportional control suitor -Proportional control switch -Hyundai Bio Hydraulic Oil (HBHO)
-----------------------------------------------------------------------------------------------------------------------------------------------------------------------------------------	--------------------------------------------------------------------------------------------------------------------------------------------------------------	---------------------------------------------------------------------------------------------------------------------------------------------------------------------------------------------	-----------------------------------------------------------------------------------------------------------------------------------------------------------------

- * Standard and optional equipment may vary. Contact your Hyundai dealer for more information. The machine may vary according to International standards.
- * The photos may include attachments and optional equipment that are not available in your area.
- * Materials and specifications are subject to change without advance notice.
- * All imperial measurements rounded off to the nearest pound or inch.

PLEASE CONTACT

